

CERRADURAS DE EMBUTIR PARA CARPINTERÍA METÁLICA



Palanca deslizante entre ejes 85 cilindro europerfil leva corta	40
• Serie 1984	40
Palanca deslizante entre ejes 85 cilindro europerfil leva larga	42
• Serie 1995	42
Palanca gancho entre ejes 85 cilindro europerfil	44
• Serie 190	44
• Serie 1990	45
• Serie 1994	46
Multipunto palanca gancho entre ejes 85	48
• Serie 2994	48
Multipunto palanca gancho entre ejes 85	50
• Serie 3994	50
• Serie 4994	52
Palanca deslizante entre ejes 92 cilindro europerfil	54
• Serie 1992	54
Palanca deslizante entre ejes 70 cilindro europerfil	55
• Serie 1983	55
Palanca deslizante entre ejes 85 cilindro ovalado monoblock	57
• Serie 1963	57
• Serie 1975	59
Palanca deslizante entre ejes 85 cilindro ovalado de vástagos	60
• Serie 1964	60
Cerradura para puertas de zócalo con cilindro ovalado de vástagos	62
• Serie 1981	62
Cerradura para puertas de zócalo con cilindro europerfil	63
• Serie 1991	63
Cerradura de sólo gancho con cilindro ovalado de vástagos	64
• Serie 1968	64
Cerradura de sólo gancho con cilindro europerfil	65
• Serie 1982	65
Cerradura de sólo picaporte para puertas metálicas	66
• Serie 1979	66
Cerradura para puertas y persianas metálicas enrollables	67
• Serie 11A	67
• Serie 11E	68
Cerradura para puertas metálicas basculantes	69
• Serie 11B	69
Accesorios	70
• Cerraderos para cerraduras metálicas	70
• Cerraderos eléctricos	73
• Escudos	74
• Escudos de seguridad	74

PALANCA DESLIZANTE ENTRE EJES 85 CILINDRO EUROPERFIL LEVA CORTA

SERIE 1984

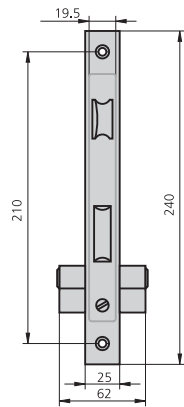

CARACTERÍSTICAS

- Frente hierro niquelado ó acero inoxidable
- Caja bicromatada
- Palanca deslizante
- Picaporte reversible
- Cuadradillo de 8mm
- Cilindro europerfil
- 2 escudos de nylon ref. ES1984
- Tornillo de fijación de cilindro

ACCESORIOS OPCIONALES

- Cerraderos según cerradura (ver abajo)
- Amplia gama de cilindros (ver página 115-123)

DESCRIPCIÓN	REF.	MEDIDAS		LEVA	ACABADOS		UDS		PRECIO	
		B	A		FRENTE	CILINDRO			COMPLETA	S/CILINDRO

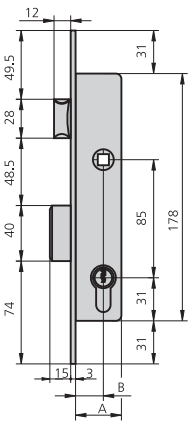

- Picaporte y palanca
- Cilindro 5990/2525

- Opciones de cerradero**
- CE1984/0 ó CE1984/6

- Opción cerraderos eléctricos**

- CELC196/6A ó CELC196/6AD

1984/20/0	20	33	13,25	HN	CN	1	20		
1984/20/5	20	33	13,25	HN	CL	1	20		
1984/20/6	20	33	13,25	AI	CN	1	20		
1984/25/0	25	38	13,25	HN	CN	1	20		
1984/25/5	25	38	13,25	HN	CL	1	20		
1984/25/6	25	38	13,25	AI	CN	1	20		
1984/30/0	30	43	13,25	HN	CN	1	20		
1984/30/5	30	43	13,25	HN	CL	1	20		
1984/30/6	30	43	13,25	AI	CN	1	20		

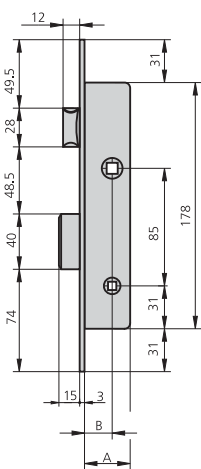

- Cerradura de condena
- Sin cilindro

- Opciones de cerradero**
- CE1984/6

1984C20/6	20	33		AI		2	40		
1984C25/6	25	38		AI		2	40		
1984C30/6	30	43		AI		2	40		

DESCRIPCIÓN	REF.	MEDIDAS		LEVA	ACABADOS		UDS		PRECIO	
		B	A		FRENTE	CILINDRO			COMPLETA	S/CILINDRO

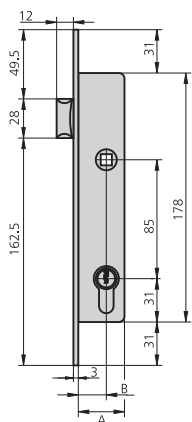

- Sólo picaporte
- Cilindro 5982T40/4

Opción cerraderos eléctricos

- CELC196T/6A ó CELC196T/6AD

1984T20/6	20	33	15	Al	CN	1	20		
1984T25/6	25	38	15	Al	CN	1	20		
1984T30/6	30	43	15	Al	CN	1	20		

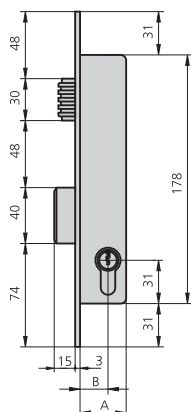

- Rodillo vaivén regulable y palanca
- Cilindro 5990/2525

Opciones de cerradero

- CE1984/6

1984V20/6	20	33	13,25	Al	CN	1	20		
1984V25/6	25	38	13,25	Al	CN	1	20		
1984V30/6	30	43	13,25	Al	CN	1	20		

PALANCA DESLIZANTE ENTRE EJES 85 CILINDRO EUROPERFIL LEVA LARGA

SERIE 1995

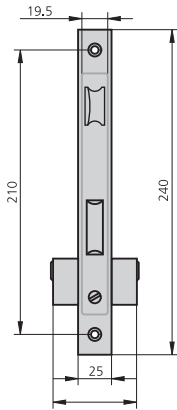

CARACTERÍSTICAS

- Frente hierro niquelado ó acero inoxidable
- Caja bicromatada
- Palanca deslizante
- Picaporte reversible
- Cudradillo de 8mm
- Cilindro europerfil
- 2 escudos de nylon ref. ES1984
- Tornillo de fijación de cilindro

ACCESORIOS OPCIONALES

- Cerraderos según cerradura (ver abajo)
- Amplia gama de cilindros (ver página 115-123)

DESCRIPCIÓN	REF.	MEDIDAS		LEVA	ACABADOS		UDS		PRECIO	
		B	A		FRENTE	CILINDRO			COMPLETA	S/CILINDRO

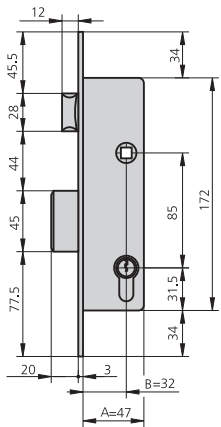

- Picaporte y palanca
- Cilindro 5982/2525
- Opciones de cerradero**
- CE1984/0 ó CE1984/6
- Opciones cerraderos eléctricos**
- CELC196/6A ó CELC196/6AD

1995/32/0	32	47	15	HN	CN	1	20		
1995/32/5	32	47	15	HN	CL	1	20		
1995/32/6	32	47	15	Al	CN	1	20		

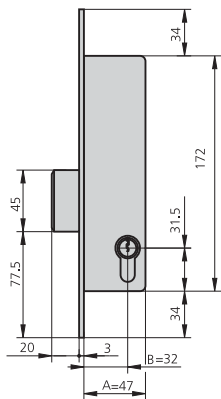

- Sólo palanca
- Cilindro 5982/2525/4
- Opciones de cerradero**
- CE2994S/6

1995A32/6	32	47	15	Al	CN	1	20		
-----------	----	----	----	----	----	---	----	--	--

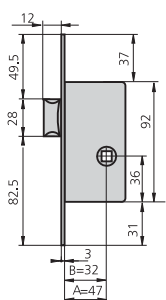

- Sólo picaporte
- Sin cilindro

1995R32/0	32	47		HN		1	30		
-----------	----	----	--	----	--	---	----	--	--

PALANCA DESLIZANTE ENTRE EJES 85 CILINDRO EUROPERFIL LEVA LARGA SERIE 1995

DESCRIPCIÓN	REF.	MEDIDAS		LEVA	ACABADOS		UDS		PRECIO	
		B	A		FRENTE	CILINDRO			COMPLETA	S/CILINDRO

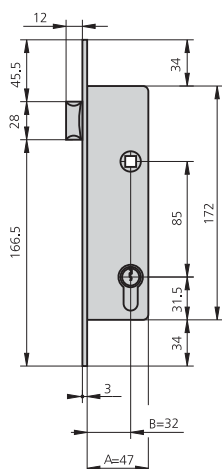

- Sólo picaporte
- Cilindro 5982T40/4

Opciones cerraderos eléctricos

- CELC196/6A ó CELC196/6AD

1995T32/6	32	47	15	Al	CN	1	20		
-----------	----	----	----	----	----	---	----	--	--

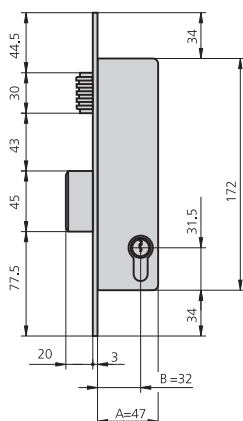

- Rodillo vaivén regulable y palanca
- Cilindro 5982/2525/4

Opciones de cerradero

- CE1984/6

1995V32/6	32	47	15	Al	CN	1	20		
-----------	----	----	----	----	----	---	----	--	--

PALANCA GANCHO ENTRE EJES 85 CILINDRO EUROPERFIL

SERIE 190

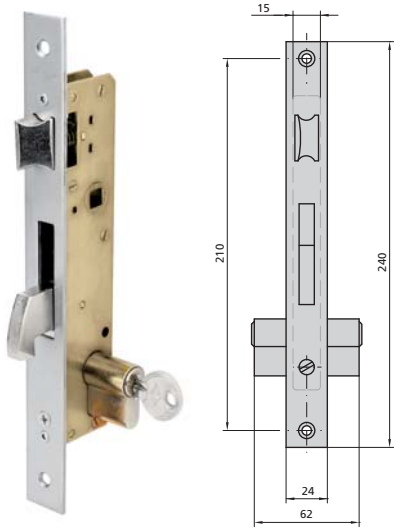

CARACTERÍSTICAS

- Frente de 24 mm
- Picaporte reversible
- Caja bicromatada de 15 mm
- Cudradillo de 8mm
- Cilindro europerfil
- 2 escudos de nylon ref. ES1984
- Tornillo de fijación de cilindro

ACCESORIOS OPCIONALES

- Amplia gama de cilindros (ver página 115-123)

DESCRIPCIÓN	REF.	MEDIDAS		LEVA	ACABADOS		UDS		PRECIO	
		B	A		FRENTE	CILINDRO			COMPLETA	S/CILINDRO

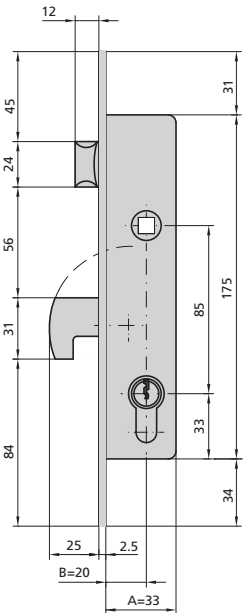

- Picaporte y palanca
- Cilindro 5990/2525

- Opciones de cerradero**
- CE190/0 ó CE190/6

190/23/0	20	33	13,25	HN	CN	1	20		
190/23/5	20	33	13,25	HN	CL	1	20		
190/23/6	20	33	13,25	AI	CN	1	20		
190/28/0	20	33	13,25	HN	CN	1	20		
190/28/5	20	33	13,25	HN	CL	1	20		
190/28/6	20	33	13,25	AI	CN	1	20		

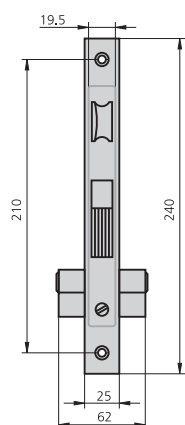
CARACTERÍSTICAS

- Frente hierro niquelado ó acero inoxidable
- Caja bicromatada
- Palanca basculante de gancho
- Picaporte reversible
- Cudradillo de 8mm
- Cilindro europerfil
- 2 escudos de nylon ref. ES1984
- Tornillo de fijación de cilindro

ACCESORIOS OPCIONALES

- Amplia gama de cilindros (ver página 115-123)

DESCRIPCIÓN	REF.	MEDIDAS		LEVA	ACABADOS		UDS		PRECIO	
		B	A		FRENTE	CILINDRO			COMPLETA	S/CILINDRO
<ul style="list-style-type: none"> • Picaporte y palanca • Cilindro 5990/2525 ó 5982/2525 • Cerradero CE1990/0 	1990/20/0	20	33	13,25	HN	CN	1	20		
	1990/20/5	20	33	13,25	HN	CL	1	20		
	1990/20/6	20	33	13,25	AI	CN	1	20		
	1990/25/0	25	38	13,25	HN	CN	1	20		
	1990/25/5	25	38	13,25	HN	CL	1	20		
	1990/25/6	25	38	13,25	AI	CN	1	20		
	1990/32/0	32	47	15	HN	CN	1	20		
	1990/32/5	32	47	15	HN	CL	1	20		
1990/32/6	32	47	15	AI	CN	1	20			
<ul style="list-style-type: none"> • Sólo palanca • Cilindro 5990/2525 ó 5982/2525 • Cerradero CE1990/0 	1990A20/0	20	33	13,25	HN	CN	1	20		
	1990A20/5	20	33	13,25	HN	CL	1	20		
	1990A20/6	20	33	13,25	AI	CN	1	20		
	1990A25/0	25	38	13,25	HN	CN	1	20		
	1990A25/5	25	38	13,25	HN	CL	1	20		
	1990A25/6	25	38	13,25	AI	CN	1	20		
	1990A32/0	32	47	15	HN	CN	1	20		
	1990A32/5	32	47	15	HN	CL	1	20		
1990A32/6	32	47	15	AI	CN	1	20			
<ul style="list-style-type: none"> • Rodillo vaivén regulable y palanca • Cilindro 5990/2525 ó 5982/2525 • Cerradero CE1990/0 	1990V20/0	20	33	13,25	HN	CN	1	20		
	1990V20/5	20	33	13,25	HN	CL	1	20		
	1990V20/6	20	33	13,25	AI	CN	1	20		
	1990V25/0	25	38	13,25	HN	CN	1	20		
	1990V25/5	25	38	13,25	HN	CL	1	20		
	1990V25/6	25	38	13,25	AI	CN	1	20		
	1990V32/0	32	47	15	HN	CN	1	20		
	1990V32/5	32	47	15	HN	CL	1	20		
1990V32/6	32	47	15	AI	CN	1	20			

PALANCA GANCHO ENTRE EJES 85 CILINDRO EUROPERFIL

SERIE 1994

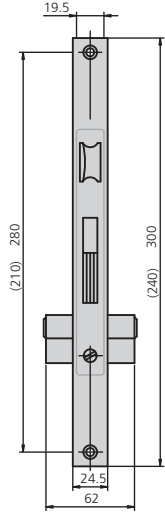

CARACTERÍSTICAS

- Frente de acero inoxidable
- Caja bicromatada
- Palanca basculante de gancho
- Picaporte reversible
- Cudradillo de 8mm
- Cilindro europerfil
- Tornillo de fijación de cilindro
- Cerradero según cerradura
- Escudo de seguridad BTI94/1N

ACCESORIOS OPCIONALES

- Amplia gama de cilindros (ver página 115-123)

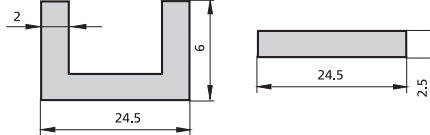

FRETE U **FRETE LISO**

DESCRIPCIÓN	REF.	MEDIDAS		LEVA	ACABADOS		UDS		PRECIO	
		B	A		FRENTE	CILINDRO			COMPLETA	S/CILINDRO

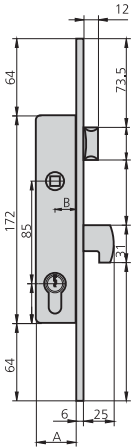

FRETE U

- Picaporte y palanca
- Cilindro 5982/2525/4
- Cerradero CE1994/6
- Escudo de seguridad BTI94/1N

1994/25/6	18	33	15	Al	CN	1	10		
1994/30/6	23	38	15	Al	CN	1	10		
1994/35/6	28	43	15	Al	CN	1	10		

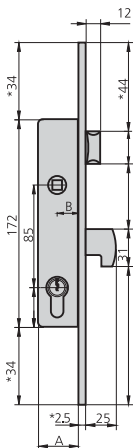

FRETE LISO

- Picaporte y palanca
- Cilindro 5982/2525/4
- Cerradero CE1994/6
- Escudo de seguridad BTI94/1N

1994/25/6L	22	37	15	Al	CN	1	20		
1994/30/6L	27	42	15	Al	CN	1	20		
1994/35/6L	32	47	15	Al	CN	1	20		

PALANCA GANCHO ENTRE EJES 85 CILINDRO EUROPERFIL

SERIE 1994

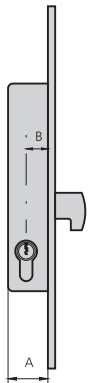
DESCRIPCIÓN	REF.	MEDIDAS		LEVA	ACABADOS		UDS		PRECIO	
		B	A		FRENTE	CILINDRO			COMPLETA	S/CILINDRO
 <p>FRENTE U</p> <ul style="list-style-type: none"> Sólo palanca Cilindro 5982/2525/4 Cerradero CE1994/6 Escudo de seguridad BT194/1N 	1994A25/6	18	33	15	Al	CN	1	10		
	1994A30/6	23	38	15	Al	CN	1	10		
	1994A35/6	28	43	15	Al	CN	1	10		
<p>FRENTE LISO</p> <ul style="list-style-type: none"> Sólo palanca Cilindro 5982/2525/4 Cerradero CE1994/6 Escudo de seguridad BT194/1N 	1994A25/6L	22	37	15	Al	CN	1	20		
	1994A30/6L	27	42	15	Al	CN	1	20		
	1994A35/6L	32	47	15	Al	CN	1	20		

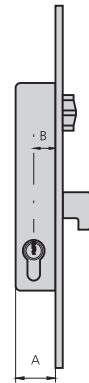
 <p>FRENTE U</p> <ul style="list-style-type: none"> Rodillo vaivén regulable y palanca Cilindro 5982/2525/4 Cerradero CE1994/6 Escudo de seguridad BT194/1N 	1994V25/6	18	33	15	Al	CN	1	10		
	1994V30/6	23	38	15	Al	CN	1	10		
	1994V35/6	28	43	15	Al	CN	1	10		
<p>FRENTE LISO</p> <ul style="list-style-type: none"> Rodillo vaivén regulable y palanca Cilindro 5982/2525/4 Cerradero CE1994/6 Escudo de seguridad BT194/1N 	1994V25/6L	22	37	15	Al	CN	1	20		
	1994V30/6L	27	42	15	Al	CN	1	20		
	1994V35/6L	32	47	15	Al	CN	1	20		

MULTIPUNTO PALANCA GANCHO ENTRE EJES 85

SERIE 2994

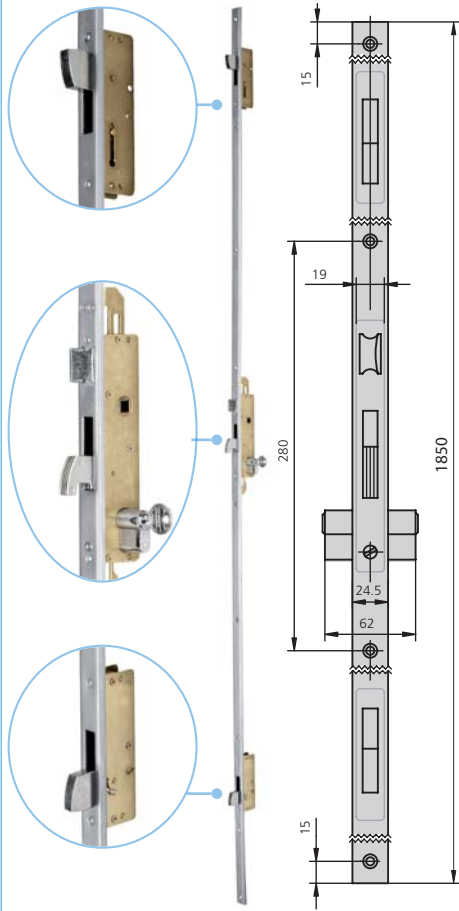

CARACTERÍSTICAS

- Frente de acero inoxidable
- Caja bicromatada
- Palanca basculante de gancho
- Picaporte reversible
- Cudradillo de 8mm
- Cilindro euoperfil de seguridad
- Tornillo de fijación de cilindro
- Cerradero según cerradura
- Escudo de seguridad BT194/1N

ACCESORIOS OPCIONALES

- Amplia gama de cilindros (ver página 115-123)

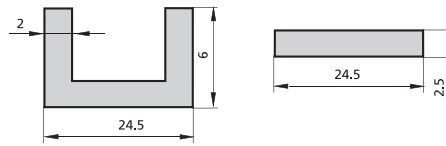

FRENTE U

FRENTE LISO

DESCRIPCIÓN	REF.	MEDIDAS		LEVA	ACABADOS		UDS	PRECIO	
		B	A		FRENTE	CILINDRO		COMPLETA	S/CILINDRO
FRENTE U <ul style="list-style-type: none"> • Picaporte y palanca • Cilindro 6982/2525/4 • Cerradero CE1994/6 • Cerradero alto/bajo CE2994S/6 • Escudo de seguridad BT194/1N 	2994/25/6	18	33	15	Al	CN	1		
	2994/30/6	23	38	15	Al	CN	1		
	2994/35/6	28	43	15	Al	CN	1		
FRENTE LISO <ul style="list-style-type: none"> • Picaporte y palanca • Cilindro 6982/2525/4 • Cerradero CE1994/6 • Cerradero alto/bajo CE2994S/6 • Escudo de seguridad BT194/1N 	2994/25/6L	22	37	15	Al	CN	1		
	2994/30/6L	27	42	15	Al	CN	1		
	2994/35/6L	32	47	15	Al	CN	1		

* Medidas en frente liso

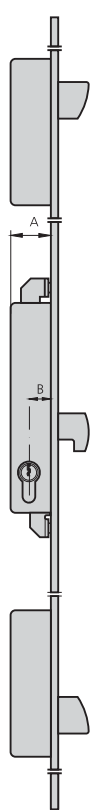
DESCRIPCIÓN	REF.	MEDIDAS		LEVA	ACABADOS		UDS	PRECIO	
		B	A		FRENTE	CILINDRO		COMPLETA	S/CILINDRO
 <p>FRENTE U</p> <ul style="list-style-type: none"> Sólo palanca Cilindro 6982/2525/4 Cerradero CE1994/6 Cerradero alto/bajo CE2994S/6 Escudo de seguridad BT194/1N 	2994A25/6	18	33	15	Al	CN	1		
	2994A30/6	23	38	15	Al	CN	1		
	2994A35/6	28	43	15	Al	CN	1		
<p>FRENTE LISO</p> <ul style="list-style-type: none"> Sólo palanca Cilindro 6982/2525/4 Cerradero CE1994/6 Cerradero alto/bajo CE2994S/6 Escudo de seguridad BT194/1N 	2994A25/6L	22	37	15	Al	CN	1		
	2994A30/6L	27	42	15	Al	CN	1		
	2994A35/6L	32	47	15	Al	CN	1		

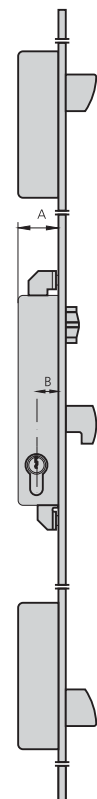
 <p>FRENTE U</p> <ul style="list-style-type: none"> Rodillo vaivén regulable y palanca Cilindro 6982/2525/4 Cerraderos CE1994/6 Cerraderos alto/bajo CE2994S/6 Escudo de seguridad BT194/1N 	2994V25/6	18	33	15	Al	CN	1		
	2994V30/6	23	38	15	Al	CN	1		
	2994V35/6	28	43	15	Al	CN	1		
<p>FRENTE LISO</p> <ul style="list-style-type: none"> Rodillo vaivén regulable y palanca Cilindro 6982/2525/4 Cerraderos CE1994/6 Cerraderos alto/bajo CE2994S/6 Escudo de seguridad BT194/1N 	2994V25/6L	22	37	15	Al	CN	1		
	2994V30/6L	27	42	15	Al	CN	1		
	2994V35/6L	32	47	15	Al	CN	1		

MULTIPUNTO PALANCA GANCHO ENTRE EJES 85

SERIE 3994

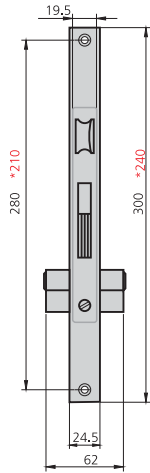

CARACTERÍSTICAS

- Cerradura de 3 puntos mediante barra roscada de M8
- Frente de acero inoxidable
- Caja bicromatada
- Palanca basculante de gancho
- Picaporte reversible
- Cudradillo de 8mm
- Cilindro de seguridad
- Tornillo de fijación de cilindro
- Cerradero según cerradura
- Escudo de seguridad ref. BTI94/1N

ACCESORIOS OPCIONALES

- Amplia gama de cilindros (ver página 115-123)

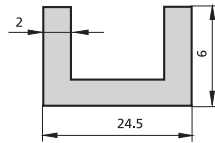

FRENTE U



FRENTE LISO

* Medidas en frente liso

DESCRIPCIÓN	REF.	MEDIDAS		LEVA	ACABADOS		UDS		PRECIO	
		B	A		FRENTE	CILINDRO			COMPLETA	S/CILINDRO

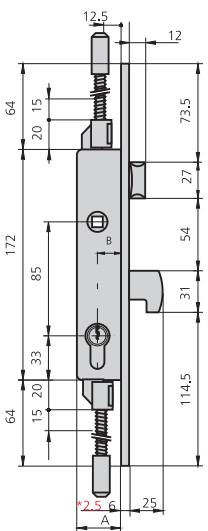

FRENTE U

- Picaporte y palanca
- Cilindro 6982/2525/4
- Cerradero CE1994/6
- Escudo de seguridad BTI94/1N

3994/25/6	18	33	15	AI	CN	1	10		
3994/30/6	23	38	15	AI	CN	1	10		
3994/35/6	28	43	15	AI	CN	1	10		

FRENTE LISO

- Picaporte y palanca
- Cilindro 6982/2525/4
- Cerradero CE1994/6
- Escudo de seguridad BTI94/1N

3994/25/6L	22	37	15	AI	CN	1	10		
3994/30/6L	27	42	15	AI	CN	1	10		
3994/35/6L	32	47	15	AI	CN	1	10		

* Medidas en frente liso

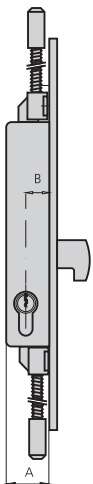

FRENTE U

- Sólo palanca
- Cilindro 6982/2525/4
- Cerradero CE1994/6
- Escudo de seguridad BTI94/1N

3994A25/6	18	33	15	AI	CN	1	10		
3994A30/6	23	38	15	AI	CN	1	10		
3994A35/6	28	43	15	AI	CN	1	10		

FRENTE LISO

- Cilindro 6982/2525/4
- Cerradero CE1994/6
- Escudo de seguridad BTI94/1N

3994A25/6L	22	37	15	AI	CN	1	10		
3994A30/6L	27	42	15	AI	CN	1	10		
3994A35/6L	32	47	15	AI	CN	1	10		

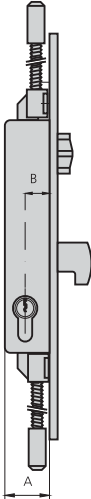
DESCRIPCIÓN	REF.	MEDIDAS		LEVA	ACABADOS		UDS		PRECIO	
		B	A		FRENTE	CILINDRO			COMPLETA	S/CILINDRO
 <ul style="list-style-type: none"> • Rodillo vaivén regulable y palanca • Cilindro 6982/2525/4 • Cerradero CE1994/6 • Escudo de seguridad BTI94/1N 	3994V25/6	18	33	15	Al	CN	1	10		
	3994V30/6	23	38	15	Al	CN	1	10		
	3994V35/6	28	43	15	Al	CN	1	10		
<ul style="list-style-type: none"> • Rodillo vaivén regulable y palanca • Cilindro 6982/2525/4 • Cerradero CE1994/6 • Escudo de seguridad BTI94/1N 	3994V25/6L	22	37	15	Al	CN	1	10		
	3994V30/6L	27	42	15	Al	CN	1	10		
	3994V35/6L	32	47	15	Al	CN	1	10		

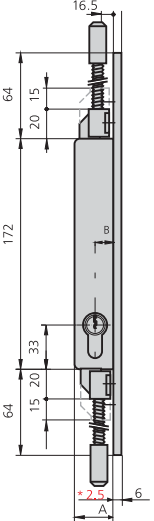
 <ul style="list-style-type: none"> • Sin palanca y sin picaporte • Cilindro 6982/2525/4 • Escudo de seguridad BTI94/1N 	3994F25/6	18	33	15	Al	CN	1	10		
	3994F30/6	23	38	15	Al	CN	1	10		
	3994F35/6	28	43	15	Al	CN	1	10		
<ul style="list-style-type: none"> • Sin palanca y sin picaporte • Cilindro 6982/2525/4 • Escudo de seguridad BTI94/1N 	3994F25/6L	22	37	15	Al	CN	1	10		
	3994F30/6L	27	42	15	Al	CN	1	10		
	3994F35/6L	32	47	15	Al	CN	1	10		

MULTIPUNTO PALANCA BASCULANTE ENTRE EJES 85

SERIE 4994

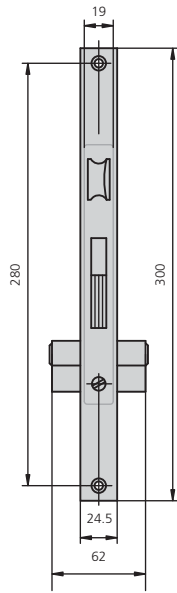

CARACTERÍSTICAS

- Cerradura de 3 puntos mediante barra perforada
- Frente de acero inoxidable
- Caja bicromatada
- Palanca basculante de gancho
- Picaporte reversible
- Cudradillo de 8mm
- Cilindro de seguridad
- Tornillo de fijación de cilindro
- Cerradero según cerradura
- Escudo de seguridad ref. BTI94/1N

ACCESORIOS OPCIONALES

- Amplia gama de cilindros (ver página 115-123)

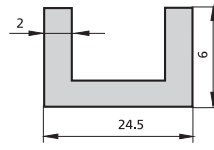

FRENTE U

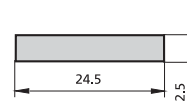

FRENTE LISO

* Medidas en frente liso

DESCRIPCIÓN	REF.	MEDIDAS		LEVA	ACABADOS		UDS		PRECIO	
		B	A		FRENTE	CILINDRO			COMPLETA	S/CILINDRO

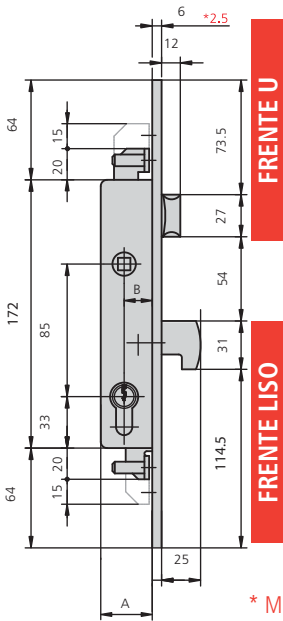

FRENTE U

- Picaporte y palanca
- Cilindro 6982/2525/4
- Cerradero CE1994/6
- Escudo de seguridad BTI94/1N

4994/25/6	18	33	15	Al	CN	1	10		
4994/30/6	23	38	15	Al	CN	1	10		
4994/35/6	28	43	15	Al	CN	1	10		

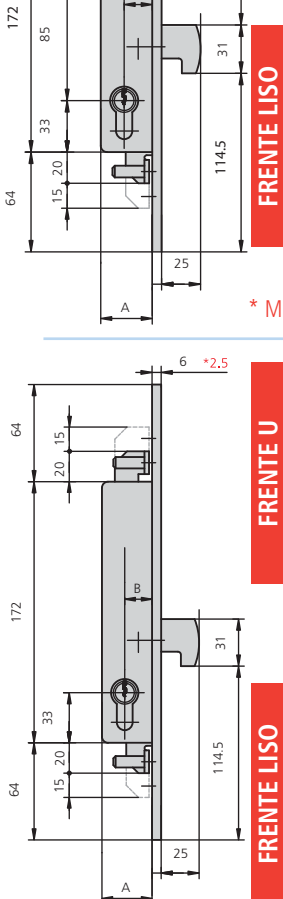

FRENTE LISO

- Picaporte y palanca
- Cilindro 6982/2525/4
- Cerradero CE1994/6
- Escudo de seguridad BTI94/1N

4994/25/6L	22	37	15	Al	CN	1	10		
4994/30/6L	27	42	15	Al	CN	1	10		
4994/35/6L	32	47	15	Al	CN	1	10		

* Medidas en frente liso

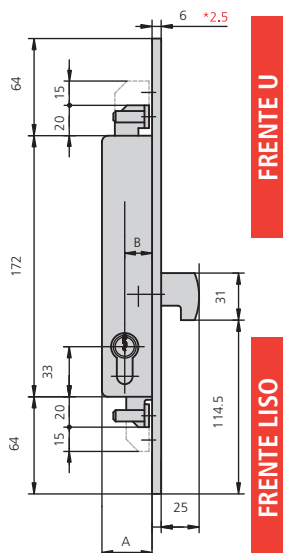

FRENTE U

- Sólo palanca
- Cilindro 6982/2525/4
- Cerradero CE1994/6
- Escudo de seguridad BTI94/1N

4994A25/6	18	33	15	Al	CN	1	10		
4994A30/6	23	38	15	Al	CN	1	10		
4994A35/6	28	43	15	Al	CN	1	10		

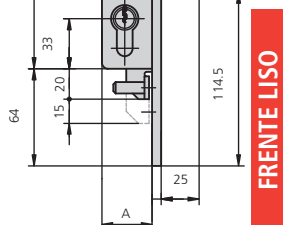

FRENTE LISO

- Sólo palanca
- Cilindro 6982/2525/4
- Cerradero CE1994/6
- Escudo de seguridad BTI94/1N

4994A25/6L	22	37	15	Al	CN	1	10		
4994A30/6L	27	42	15	Al	CN	1	10		
4994A35/6L	32	47	15	Al	CN	1	10		

* Medidas en frente liso

PALANCA DESLIZANTE ENTRE CENTROS 70 M.M.
SERIE 4994

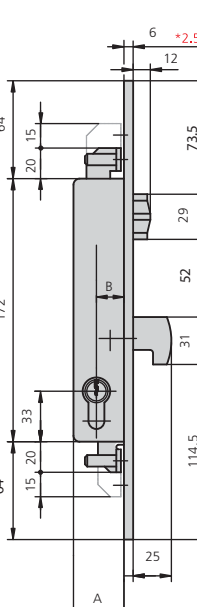
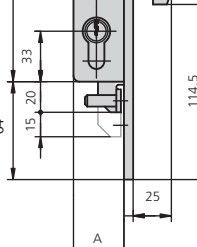
DESCRIPCIÓN	REF.	MEDIDAS		LEVA	ACABADOS		UDS		PRECIO	
		B	A		FRENTE	CILINDRO			COMPLETA	S/CILINDRO
 <p>FRENTE U</p> <ul style="list-style-type: none"> Rodillo vaivén regulable y palanca Cilindro 6982/2525/4 Cerradero CE1994/6 Escudo de seguridad BTI94/1N 	4994V25/6	18	33	15	Al	CN	1	10		
	4994V30/6	23	38	15	Al	CN	1	10		
	4994V35/6	28	43	15	Al	CN	1	10		
 <p>FRENTE LISO</p> <ul style="list-style-type: none"> Rodillo vaivén regulable y palanca Cilindro 6982/2525/4 Cerradero CE1994/6 Escudo de seguridad BTI94/1N 	4994V25/6L	22	37	15	Al	CN	1	10		
	4994V30/6L	27	42	15	Al	CN	1	10		
	4994V35/6L	32	47	15	Al	CN	1	10		

* Medidas en frente liso

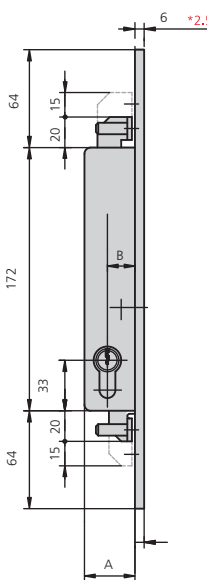
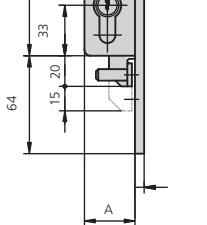
 <p>FRENTE U</p> <ul style="list-style-type: none"> Sin palanca y sin picaporte Cilindro 6982/2525/4 Escudo de seguridad BTI94/1N 	4994F25/6	18	33	15	Al	CN	1	10		
	4994F30/6	23	38	15	Al	CN	1	10		
	4994F35/6	28	43	15	Al	CN	1	10		
 <p>FRENTE LISO</p> <ul style="list-style-type: none"> Sin palanca y sin picaporte Cilindro 6982/2525/4 Cerradero CE1994/6 Escudo de seguridad BTI94/1N 	4994F25/6L	22	37	15	Al	CN	1	10		
	4994F30/6L	27	42	15	Al	CN	1	10		
	4994F35/6L	32	47	15	Al	CN	1	10		

* Medidas en frente liso

PALANCA DESLIZANTE ENTRE EJES 92 CILINDRO EUROPERFIL

SERIE 1992

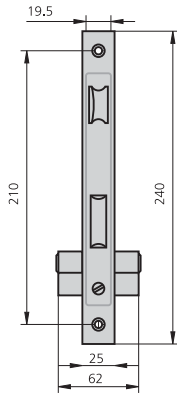

CARACTERÍSTICAS

- Frente de acero inoxidable
- Caja bicromatada
- Palanca deslizante
- Picaporte reversible
- Cuadrado de 8mm
- Cilindro europerfil
- 2 escudos de nylon ref. ES1984
- Tornillo de fijación de cilindro

ACCESORIOS OPCIONALES

- Cerraderos según cerradura (ver abajo)
- Amplia gama de cilindros (ver página 115-123)

DESCRIPCIÓN	REF.	MEDIDAS		LEVA	ACABADOS		UDS		PRECIO	
		B	A		FRENTE	CILINDRO			COMPLETA	S/CILINDRO

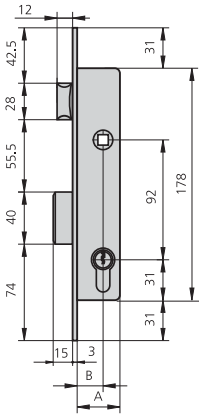

- Picaporte y palanca
- Cilindro 5990/2525/4
- Opciones de cerradero**
- CE1984/6
- Opciones cerraderos eléctricos**
- CELC196/6A ó CELC196/6AD

1992/20/6	20	33	13,25	Al	CN	1	20		
1992/25/6	25	38	13,25	Al	CN	1	20		
1992/30/6	30	43	13,25	Al	CN	1	20		

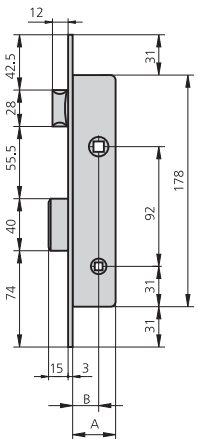

- Cerradura de condena
- Sin cilindro
- Opciones de cerradero**
- CE1984/6

1992C20/6	20	33		Al		2	40		
1992C25/6	25	38		Al		2	40		
1992C30/6	30	43		Al		2	40		

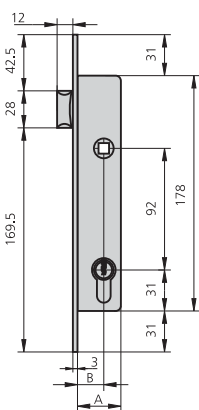

- Sólo picaporte
- Cilindro 5982T40/4
- Opciones cerraderos eléctricos**
- CELC196T/6A ó CELC196T/6AD

1992T20/6	20	33	15	Al	CN	1	20		
1992T25/6	25	38	15	Al	CN	1	20		
1992T30/6	30	43	15	Al	CN	1	20		

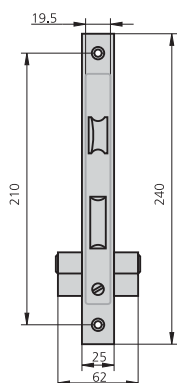

CARACTERÍSTICAS

- Frente hierro niquelado ó acero inoxidable
- Caja bicromatada
- Palanca deslizante
- Picaporte reversible
- Cuadradillo de 8mm
- Cilindro europerfil
- 2 escudos de nylon ref. ES1984
- Tornillo de fijación de cilindro

ACCESORIOS OPCIONALES

- Cerraderos según cerradura (ver abajo)
- Amplia gama de cilindros (ver página 115-123)

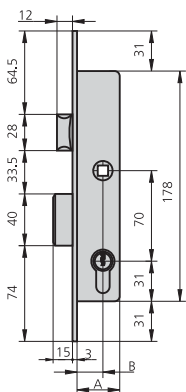
DESCRIPCIÓN	REF.	MEDIDAS		LEVA	ACABADOS		UDS		PRECIO	
		B	A		FRENTE	CILINDRO			COMPLETA	S/CILINDRO



- Picaporte y palanca
- Cilindro 5990/2525
- Opciones de cerradero**
- CE1983/0 ó CE1983/6

1983/20/0	20	33	13,25	HN	CN	1	20		
1983/20/5	20	33	13,25	HN	CL	1	20		
1983/20/6	20	33	13,25	AI	CN	1	20		
1983/25/0	25	38	13,25	HN	CN	1	20		
1983/25/5	25	38	13,25	HN	CL	1	20		
1983/25/6	25	38	13,25	AI	CN	1	20		
1983/30/0	30	43	13,25	HN	CN	1	20		
1983/30/5	30	43	13,25	HN	CL	1	20		
1983/30/6	30	43	13,25	AI	CN	1	20		

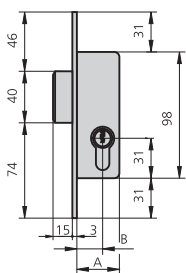

- Sólo palanca
- Cilindro 5990/2525
- Opciones de cerradero**
- CE2994S/6

1983A20/0	20	33	13,25	HN	CN	1	30		
1983A20/5	20	33	13,25	HN	CL	1	30		
1983A25/0	25	38	13,25	HN	CN	1	30		
1983A25/5	25	38	13,25	HN	CL	1	30		
1983A30/0	30	43	13,25	HN	CN	1	30		
1983A30/5	30	43	13,25	HN	CL	1	30		

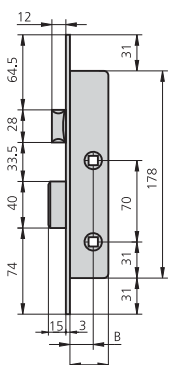



- Cerradura de condensa
- Sin cilindro
- Opciones de cerradero**
- CE1983/6

1983C20/6	20	33		AI		2	40		
1983C25/6	25	38		AI		2	40		
1983C30/6	30	43		AI		2	40		

PALANCA DESLIZANTE ENTRE EJES 70 CILINDRO EUROPERFIL

SERIE 1983

DESCRIPCIÓN	REF.	MEDIDAS		LEVA	ACABADOS		UDS		PRECIO	
		B	A		FRENTE	CILINDRO			COMPLETA	S/CILINDRO
<ul style="list-style-type: none"> • Cerradura de sólo picaporte • Sin cilindro 	1983R20/0	20	33		HN	2	60			
	1983R25/0	25	38		HN	2	60			
	1983R30/0	30	43		HN	2	60			

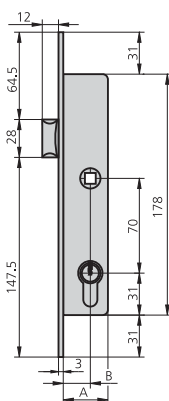
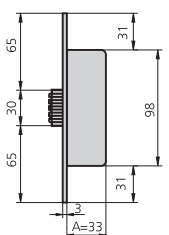
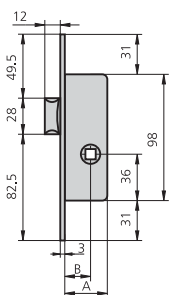

<ul style="list-style-type: none"> • Cerradura de sólo vaivén • Sin cilindro 	1983RV/0		33		HN	2	60		
--	----------	--	----	--	----	---	----	--	--

<ul style="list-style-type: none"> • Sólo picaporte • Cilindro 5982T40/4 	1983T20/6	20	33	15	Al	CN	1	20		
	1983T25/6	25	38	15	Al	CN	1	20		
	1983T30/6	30	43	15	Al	CN	1	20		

Opciones de cerraderos eléctricos

- CELC196T/6A ó CELC196T/6AD

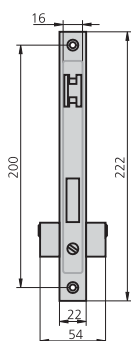

CARACTERÍSTICAS

- Frente de hierro niquelado o acero inoxidable
- Caja bicromatada
- Palanca deslizante
- Picaporte reversible
- Cuadradillo de 8mm
- Cilindro ovalado monoblock (5963)
- 2 escudos de nylon ref. ES1963
- Tornillo de fijación de cilindro

ACCESORIOS OPCIONALES

- Cerraderos según cerradura (ver abajo)
- Cilindros (ver página 124)

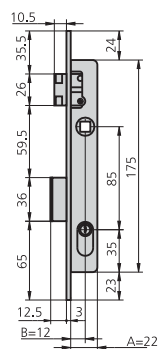
DESCRIPCIÓN	REF.	MEDIDAS		LEVA	ACABADOS		UDS		PRECIO	
		B	A		FRENTE	CILINDRO			COMPLETA	S/CILINDRO



- Picaporte y palanca
 - Cilindro 5963/2222
- Opciones de cerradero**
- CE1984/0 ó CE1984/6

1963/0	12	22	HN	CN	1	20		
1963/5	12	22	HN	CL	1	20		
1963/6	12	22	Al	CN	1	20		

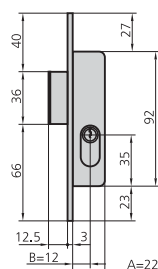

- Cerradura de sólo palanca
 - Cilindro 5963/2222
- Opciones de cerradero**
- CE2994S/6

1963A/0	12	22	HN	CN	1	30		
1963A/5	12	22	HN	CL	1	30		
1963A/6	12	22	Al	CN	1	30		

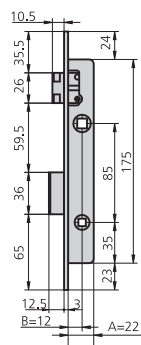



- Cerradura de condena
 - Sin cilindro
- Opciones de cerradero**
- CE1984/6

1963C/6	12	22	Al		2	40		
---------	----	----	----	--	---	----	--	--

PALANCA DESLIZANTE ENTRE EJES 85 CILINDRO OVALADO MONOBLOCK

SERIE 1963

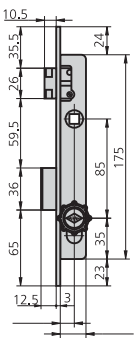
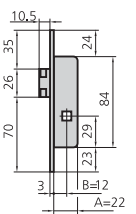
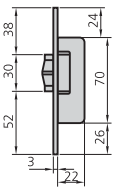
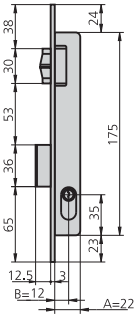
DESCRIPCIÓN	REF.	MEDIDAS		LEVA	ACABADOS		UDS		PRECIO	
		B	A		FRENTE	CILINDRO			COMPLETA	S/CILINDRO
 <ul style="list-style-type: none"> • Cerradura de pomo condensa • Sin cilindro <p>Opciones de cerradero</p> <ul style="list-style-type: none"> • CE1984/6 	1963CP16/6	12	22		Al		1	20		
 <ul style="list-style-type: none"> • Cerradura de sólo pica- porte • Sin cilindro <p>Opciones de cerradero</p> <ul style="list-style-type: none"> • Cerradero CE196R/6 	1963R/0	12	22		HN		2	60		
 <ul style="list-style-type: none"> • Cerradura de sólo vaivén • Sin cilindro <p>Opciones de cerradero</p> <ul style="list-style-type: none"> • CE196R/6 	1963RV/0		22		HN		2	60		
 <ul style="list-style-type: none"> • Rodillo vaivén regulable y palanca • Cilindro 5963/2222 <p>Opciones de cerradero</p> <ul style="list-style-type: none"> • CE1984/0 ó CE1984/6 	1963V/0	12	22		HN	CN	1	20		
	1963V/5	12	22		HN	CL	1	20		
	1963V/6	12	22		Al	CN	1	20		

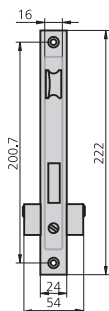
CARACTERÍSTICAS

- Frente de hierro niquelado
- Caja bicromatada
- Palanca deslizante
- Picaporte reversible
- Cuadradillo de 8mm
- Cilindro ovalado monoblock (5963)
- 2 escudos de nylon ref. ES1963
- Tornillo de fijación de cilindro

ACCESORIOS OPCIONALES

- Cerraderos según cerradura (ver abajo)
- Cilindros (ver página 124)

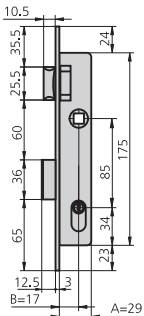
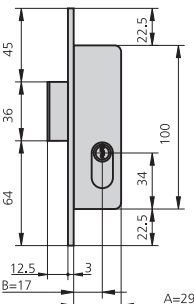
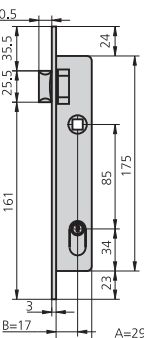
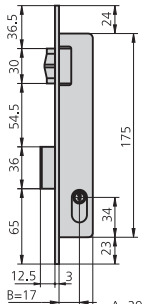
DESCRIPCIÓN	REF.	MEDIDAS		LEVA	ACABADOS		UDS		PRECIO	
		B	A		FRENTE	CILINDRO			COMPLETA	S/CILINDRO
 <ul style="list-style-type: none"> • Picaporte y palanca • Cilindro 5963/2222 <p>Opciones de cerradero</p> <ul style="list-style-type: none"> • CE1984/0 	1975/0	17	34		HN	CN	1	20		
	1975/5	17	34		HN	CL	1	20		
 <ul style="list-style-type: none"> • Cerradura de sólo palanca • Cilindro 5963/2222 <p>Opciones de cerradero</p> <ul style="list-style-type: none"> • CE2994S/6 	1975A/0	17	34		HN	CN	1	30		
	1975A/5	17	34		HN	CL	1	30		
 <ul style="list-style-type: none"> • Cerradura con sólo picaporte • Cilindro 5963T36 <p>Opciones de cerraderos eléctricos</p> <ul style="list-style-type: none"> • CELC196T/6A ó CELC196T/6AD 	1975T/0	17	34		HN	CN	1	20		
	1975T/5	17	34		HN	CL	1	20		
 <ul style="list-style-type: none"> • Rodillo vaivén regulable y palanca • Cilindro 5963/2222 <p>Opciones de cerradero</p> <ul style="list-style-type: none"> • CE1984/0 	1975V/0	17	34		HN	CN	1	20		
	1975V/5	17	34		HN	CL	1	20		

PALANCA DESLIZANTE ENTRE EJES 85 CILINDRO OVALADO DE VÁSTAGOS

SERIE 1964

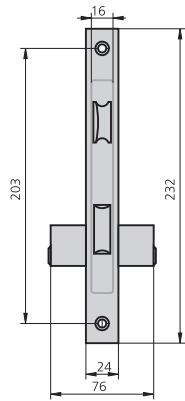

CARACTERÍSTICAS

- Frente de hierro niquelado o acero inoxidable
- Caja bicromatada
- Palanca deslizante
- Picaporte reversible
- Cuadradillo de 8mm
- Cilindro ovalado monoblock (5964)
- 2 escudos de nylon ref. ES1964
- Tornillo de fijación de cilindro

ACCESORIOS OPCIONALES

- Cerraderos según cerradura (ver abajo)
- Cilindros (ver página 128)

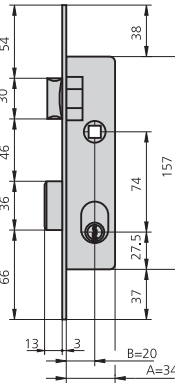
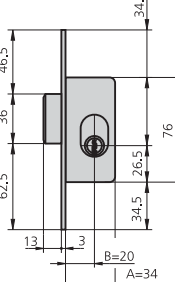
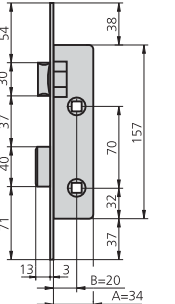
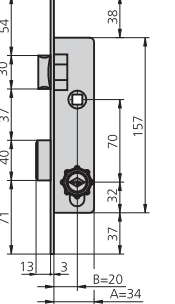
DESCRIPCIÓN	REF.	MEDIDAS		LEVA	ACABADOS		UDS		PRECIO	
		B	A		FRENTE	CILINDRO			COMPLETA	S/CILINDRO
 <ul style="list-style-type: none"> • Picaporte y palanca • Cilindro ovalado 5964/2525 <p>Opciones de cerradero</p> <ul style="list-style-type: none"> • CE1984/0 ó CE1984/6 	1964/0	20	34		HN	CN	1	20		
	1964/5	20	34		HN	CL	1	20		
	1964/6	20	34		AI	CN	1	20		
 <ul style="list-style-type: none"> • Cerradura de sólo palanca • Cilindro ovalado 5964/2525 <p>Opciones de cerradero</p> <ul style="list-style-type: none"> • CE2994S/6 	1964A/0	20	34		HN	CN	1	30		
	1964A/5	20	34		HN	CL	1	30		
 <ul style="list-style-type: none"> • Cerradura de condena • Sin cilindro <p>Opciones de cerradero</p> <ul style="list-style-type: none"> • CE1984/0 ó CE1984/6 	1964C/0	20	34		HN		2	40		
	1964C/6	20	34		AI		2	40		
 <ul style="list-style-type: none"> • Cerradura de pomo condena • Sin cilindro <p>Opciones de cerradero</p> <ul style="list-style-type: none"> • CE1984/6 	1964CP/6	20	34		AI		1	20		

DESCRIPCIÓN	REF.	MEDIDAS		LEVA	ACABADOS		UDS		PRECIO	
		B	A		FRENTE	CILINDRO			COMPLETA	S/CILINDRO
<ul style="list-style-type: none"> Cerradura de sólo pica- porte Sin cilindro <p>Opciones de cerradero</p> <ul style="list-style-type: none"> CE196R/6L 	1964R/0	20	34		HN		2	60		
	<ul style="list-style-type: none"> Cerradura de sólo vaivén Sin cilindro <p>Opciones de cerradero</p> <ul style="list-style-type: none"> CE196R/6L 	1964RV/0		34		HN		2	60	
<ul style="list-style-type: none"> Cerradura de sólo pica- porte Cilindro 5964T25 <p>Opciones de cerraderos eléctricos</p> <ul style="list-style-type: none"> CELC196T/6A ó CELC196T/6AD 		1964T/0	20	34		HN	CN	1	20	
	1964T/5	20	34		HN	CL	1	20		
	1964T/6	20	34		AI	CN	1	20		
<ul style="list-style-type: none"> Rodillo vaivén regulable y palanca Cilindro 5964/2525 <p>Opciones de cerradero</p> <ul style="list-style-type: none"> CE1984/0 ó CE1984/6 	1964V/0	20	34		HN	CN	1	20		
	1964V/5	20	34		HN	CL	1	20		
	1964V/6	20	34		AI	CN	1	20		

CERRADURA PARA PUERTAS DE ZÓCALO CON CILINDRO OVALADO DE VÁSTAGOS

SERIE 1981

CARACTERÍSTICAS

- Frente de hierro niquelado
- Caja bicromatada
- Picaporte extensible y reversible
- Accionamiento extensible con llave. Accionamiento del picaporte con llave y manilla
- Cuadradillo de 8mm
- Cilindro ovalado monoblock (5081) o cilindro redondo monoblock (5181)
- 2 escudos de nylon ref. ES1964 ó ES1962/4
- Tornillo de fijación de cilindro
- Cerradero CE1991/0

ACCESORIOS OPCIONALES

- Cilindros (ver página 125)

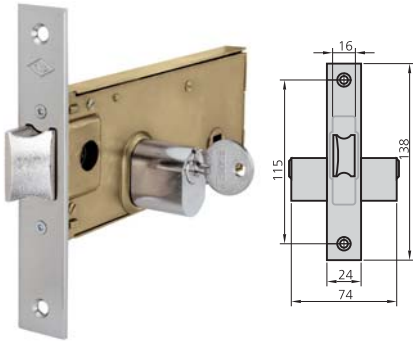

DESCRIPCIÓN	REF.	MEDIDAS		LEVA	ACABADOS		UDS		PRECIO	
		B	A		FRENTE	CILINDRO			COMPLETA	S/CILINDRO

CILINDRO OVALADO

- Cilindro ovalado 5081/3030
- Cerradero CE1991/0
- Escudo de nylon ES1964

1981/60/0	57	152		HN	CN	1	20		
1981/60/5	57	152		HN	CL	1	20		

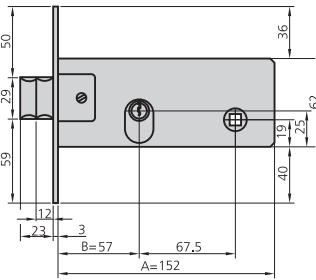

CILINDRO REDONDO

- Cilindro redondo 5181/3030
- Cerradero CE1991/0
- Escudo ES1962/4

11981/60/0	57	152		HN	CN	1	20		
11981/60/5	57	152		HN	CL	1	20		

CILINDRO OVALADO

- Vaivén extensible
- Cilindro ovalado 5081/3030
- Cerradero CE1991/0
- Escudo de nylon ES1964

1981V60/0	57	152		HN	CN	1	20		
1981V60/5	57	152		HN	CL	1	20		

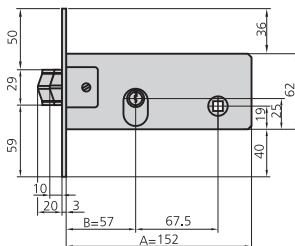

CILINDRO REDONDO

- Vaivén extensible
- Cilindro redondo 5181/3030
- Cerradero CE1991/0
- Escudo ES1962/4

11981V60/0	57	152		HN	CN	1	20		
11981V60/5	57	152		HN	CL	1	20		

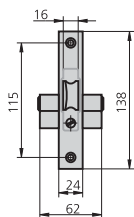

CARACTERÍSTICAS

- Frente de hierro niquelado
- Caja bicromatada
- Picaporte extensible y reversible
- Accionamiento extensible con llave. Accionamiento del picaporte con llave y manilla
- Cuadradillo de 8mm
- Cilindro europerfil
- 2 escudos de nylon ref. ES1984
- Tornillo de fijación de cilindro
- Cerradero CE1991/0

ACCESORIOS OPCIONALES

- Amplia gama de cilindros (ver página 115-123)

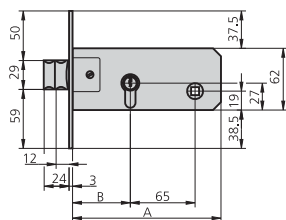
DESCRIPCIÓN	REF.	MEDIDAS		LEVA	ACABADOS		UDS		PRECIO	
		B	A		FRENTE	CILINDRO			COMPLETA	S/CILINDRO
<ul style="list-style-type: none"> • Picaporte extensible y reversible • Cilindro europerfil 5982/2525 • Cerradero CE1991/0 	1991/60/0	58	149	15	HN	CN	1	20		
	1991/60/5	58	149	15	HN	CL	1	20		
	1991/70/0	68	159	15	HN	CN	1	20		
	1991/70/5	68	159	15	HN	CL	1	20		



CERRADURA DE SÓLO GANCHO CON CILINDRO OVALADO DE VÁSTAGOS

SERIE 1968

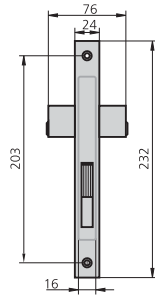

CARACTERÍSTICAS

- Frente de hierro niquelado
- Caja bicromatada
- Palanca de gancho
- Cilindro ovalado monoblock de vástagos
- 2 escudos de nylon ref. ES1964
- Tornillo de fijación de cilindro

ACCESORIOS OPCIONALES

DESCRIPCIÓN	REF.	MEDIDAS		LEVA	ACABADOS		UDS		PRECIO	
		B	A		FRENTE	CILINDRO			COMPLETA	S/CILINDRO
<ul style="list-style-type: none"> • Cerradura con palanca basculante de gancho • Cilindro 5968/2525 	1968/0	17	34		HN	CN	1	20		
	1968/5	17	34		HN	CL	1	20		

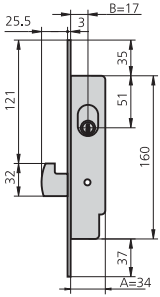

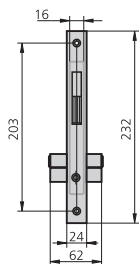
CARACTERÍSTICAS

- Frente de hierro niquelado
- Caja bicromatada
- Palanca de gancho
- Cilindro europerfil
- 2 escudos de nylon ref. ES1984
- Tornillo de fijación de cilindro

ACCESORIOS OPCIONALES

DESCRIPCIÓN	REF.	MEDIDAS		LEVA	ACABADOS		UDS		PRECIO	
		B	A		FRENTE	CILINDRO			COMPLETA	S/CILINDRO
<ul style="list-style-type: none"> • Cerradura con palanca basculante de gancho • Cilindro 5982/2525 	1982/0	17	34		HN	CN	1	20		
	1982/5	17	34		HN	CL	1	20		

CERRADURA DE SÓLO PICAPORTE PARA PUERTAS METÁLICAS

SERIE 1979

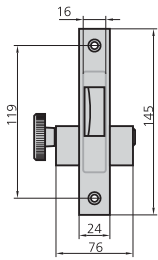

CARACTERÍSTICAS

- Frente de hierro niquelado
- Caja bicromatada
- Picaporte reversible accionado con llave por el exterior y con pomo por el interior o accionamiento con llave por ambos lados.
- Cilindro ovalado monoblock de vástagos
- 2 escudos de nylon ref. ES1964
- Tornillo de fijación de cilindro

ACCESORIOS OPCIONALES

DESCRIPCIÓN	REF.	MEDIDAS		LEVA	ACABADOS		UDS		PRECIO	
		B	A		FRENTE	CILINDRO			COMPLETA	S/CILINDRO

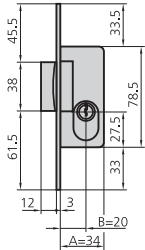

- Picaporte reversible accionado con llave por el exterior y pomo por el interior
- 5979P3030

1979P/0	20	34	HN	CN	1	30		
1979P/5	20	34	HN	CL	1	30		

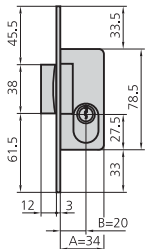



- Picaporte reversible accionado con llave por el exterior y por el interior
- 5979/3030

1979/0	20	34	HN	CN	1	30		
1979/5	20	34	HN	CL	1	30		

CARACTERÍSTICAS

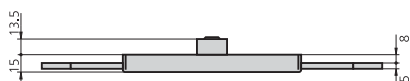
- Cerradura para puertas metálicas enrollables
- Accionamiento exterior e interior mediante llave.
- Caja bicromatada
- Cilindro redondo de 3 pitones

ACCESORIOS OPCIONALES

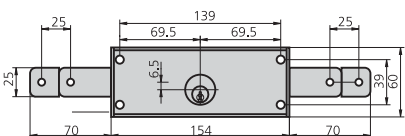
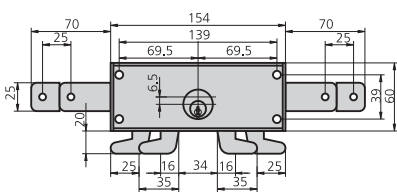
DESCRIPCIÓN	REF.	MEDIDAS		LEVA	ACABADOS		UDS		PRECIO	
		B	A		FRENTE	CILINDRO			COMPLETA	S/CILINDRO
• Dos puntos de cierre laterales	11A	60	154		CL		1	24		
										
• Dos puntos de cierre laterales y un punto inferior	11A/3P	60	154		CL		1			
										

CERRADURA PARA PUERTAS Y PERSIANAS METÁLICAS ENROLLABLES

SERIE 11E

CARACTERÍSTICAS

- Cerradura para persiana metálica enrollable
- Accionamiento exterior e interior mediante llave.
- Cilindro redondo de 3 pitones

ACCESORIOS OPCIONALES

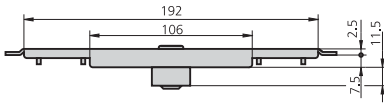

DESCRIPCIÓN

REF.

MEDIDAS
B A

LEVA

ACABADOS
FRENTE CILINDRO

UDS
 

PRECIO
COMPLETA S/CILINDRO

- Dos puntos de cierre horizontales

11E	30	216		CL	1	20		
-----	----	-----	--	----	---	----	--	--

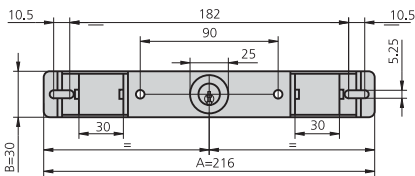

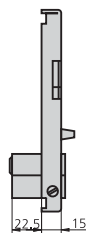

CARACTERÍSTICAS

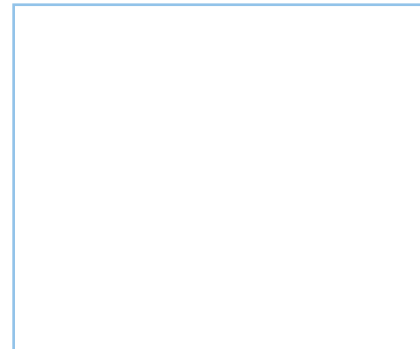
- Accionamiento mediante manilla.
- Bloqueo interior mediante botón, bloqueo exterior mediante llave.
- 2 puntos de cierre horizontales
- Caja bicromatada
- Medio cilindro monoblock ref. 5982T40/3
- Opcionalmente con set de escudo y manillas (ref. 11B/M)
- 1 Escudo ref. ES1960

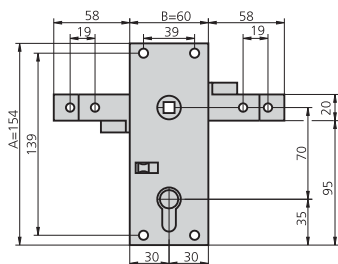

ACCESORIOS OPCIONALES

DESCRIPCIÓN	REF.	MEDIDAS		LEVA	ACABADOS		UDS		PRECIO	
		B	A		FRENTE	CILINDRO			COMPLETA	S/CILINDRO
• Dos puntos de cierre horizontales	11B	60	154	15	CL		1	40		
• Medio cilindro monoblock 5982T40/3	11B/M	60	154	15	CL		1	40		



ACCESORIOS

CERRADEROS PARA CERRADURAS METÁLICAS

DESCRIPCIÓN	REF.	ACABADO	APLICABLE A CERRADURAS	UDS  	PRECIO COMPLETA	S/CILINDRO
-------------	------	---------	------------------------	---	-----------------	------------

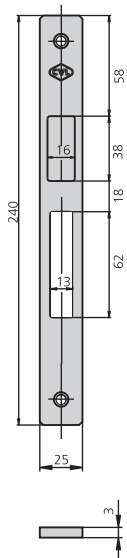

CE1983/0	HN	1983				
CE1983/6	Al					

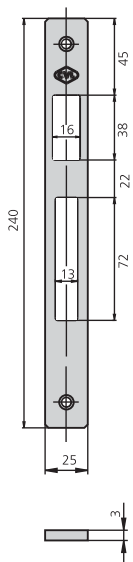

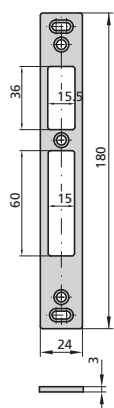

CE1984

CE1984/0	HN	1984, 1992, 1995,				
CE1984/6	Al	1964, 1963, 1975				



CE190/0	HN	190				
CE190/6	Al	190				

DESCRIPCIÓN	REF.	ACABADO	APLICABLE A CERRADURAS	UDS  	PRECIO COMPLETA S/CILINDRO
-------------	------	---------	------------------------	---	----------------------------

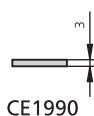
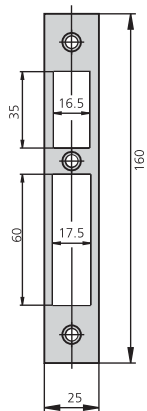
CE1990

CE1990/0 HN 1990

-----	-----
-------	-------

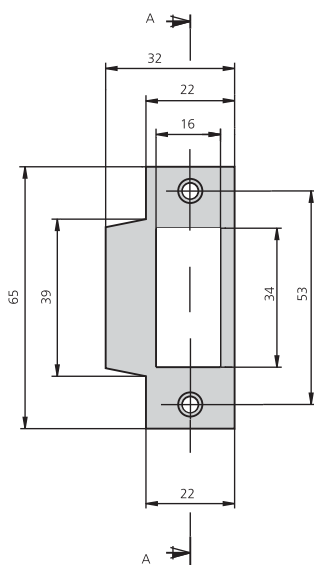
CE1991

CE1991/0 HN 1991, 1981, 11981

-----	-----
-------	-------

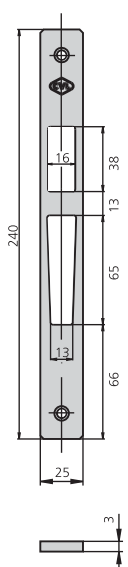

CE1994/6 Al 1994, 2994

-----	-----
-------	-------

ACCESORIOS

CERRADEROS PARA CERRADURAS METÁLICAS

DESCRIPCIÓN	REF.	ACABADO	APLICABLE A CERRADURAS	UDS 	PRECIO COMPLETA S/CILINDRO
-------------	------	---------	------------------------	---	----------------------------

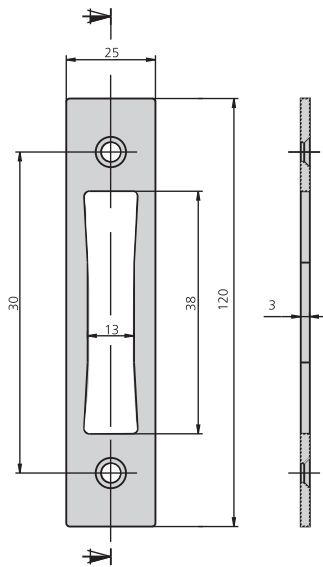





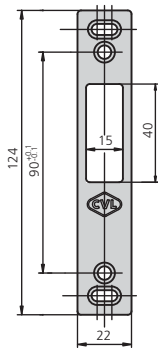





CE2994S/6 Al 1983A, 1963A, 1975A, 1995A, alto/bajo 2994

--	--

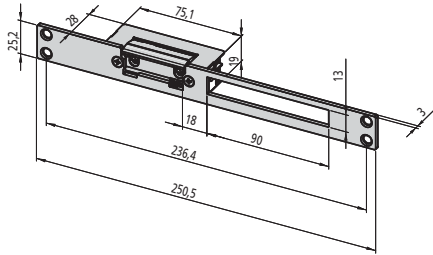

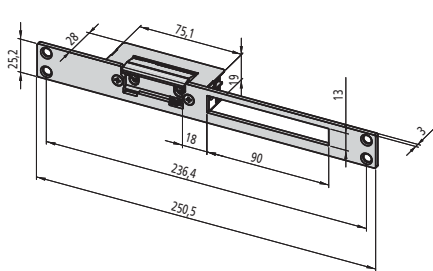

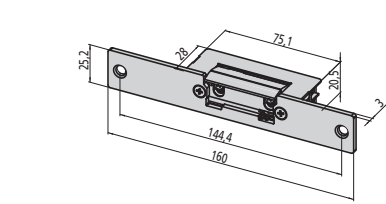
CE196R/6 Al 1963R, 1964R, 1983R, 1995R

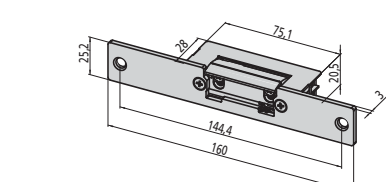
--	--

DESCRIPCIÓN	REF.	APLICABLE A CERRADURAS	UDS 	PRECIO COMPLETA S/CILINDRO 
<ul style="list-style-type: none"> • Cerradero eléctrico regulable reversible con funcionamiento automático • Frente plano inox 	CELC45/6A	<hr style="border-top: 1px dashed #ccc;"/>		
				
<ul style="list-style-type: none"> • Cerradero eléctrico regulable reversible con funcionamiento automático y con desbloqueo • Frente plano inox 	CELC45/6AD	<hr style="border-top: 1px dashed #ccc;"/>		
				
<ul style="list-style-type: none"> • Cerradero eléctrico regulable reversible con funcionamiento automático • Sólo picaporte y frente plano inox 	CELC45T/6A	<hr style="border-top: 1px dashed #ccc;"/>		
				
<ul style="list-style-type: none"> • Cerradero eléctrico regulable reversible con funcionamiento automático y con desbloqueo • Sólo picaporte y frente plano inox 	CELC45T/6AD	<hr style="border-top: 1px dashed #ccc;"/>		
				

ACCESORIOS

ESCUDOS

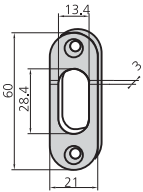
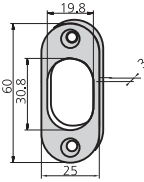
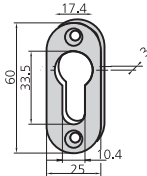
DESCRIPCIÓN	REF.	ACABADO	APLICABLE A CERRADURAS	UDS		PRECIO	
						COMPLETA	S/CILINDRO
	ES1963	Escudo de nylon	1963, 1975				
	ES1964	Escudo de nylon	1964, 1968, 1979, 1981				
	ES1984	Escudo de nylon	1982, 1983, 1984, 1990, 1992, 1994, 1995, 196, 184, 183, 192, 194, 194, P194				

ACCESORIOS

ESCUDOS DE SEGURIDAD

DESCRIPCIÓN	REF.	ACABADO	APLICABLE A CERRADURAS	UDS		PRECIO	
						COMPLETA	S/CILINDRO
	BT194/1N BT194/1NM BT194/1PL	Negro Niquel mate Plata	1983, 1984, 1990, 1992, 1994, 1995, 2994, 183, 184, 192				
							
		NEGRO	NIQUEL MATE	PLATA			