

CERRADURAS DE SOBREPONER

	Cerradura de sobreponer Serie 56	76
	• Serie 56A	76
	• Serie 56B	77
	• Serie 56C	78
	Cerradura de sobreponer Serie 125	79
	• Serie 125A	79
	• Serie 125B	80
	Cerradura de sobreponer Serie 124	81
	• Serie 124A	81
	Cerradura de sobreponer Serie 122	82
	• Serie 122A	82
	• Serie 122C	83
	Cerradura de sobreponer Serie 123	84
	• Serie 123A	84
	• Serie 123C	85
Cerrojos	86	
• Serie 1976	86	
• Serie 1978	87	
• Serie 1988	88	
Picaportes	89	
• Serie 234	89	
• Serie 236	90	
Cerraderos eléctricos	91	

CERRADURA DE SOBREPONER SERIE 56

SERIE 56A

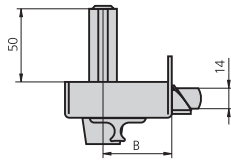

CARACTERÍSTICAS

- Picaporte accionado por llave exteriormente y con llave y tirador desde el interior.
- Palanca de una vuelta de llave accionable por ambos lados.
- Posibilidad de elección entre cilindro de perfil o cilindro redondo.
- Dos acabados: hierro esmaltado y hierro niquelado.
- Cerradero según cerradura.
- Embellecedor según tipo de cilindro.
- componentes de sujeción.

ACCESORIOS OPCIONALES

- Cerraderos eléctricos (ver página 91)
- Cilindro de seguridad

DESCRIPCIÓN	REF.	MEDIDAS		CILINDRO	ACABADOS		UDS		PRECIO	
		B	A		FRENTE	CILINDRO			COMPLETA	S/CILINDRO
• Cilindro perfil ref. 5056/50/3	56A60D/0	35	60	5056/50/3	HN	CL	1	24		
	56A60I/0	35	60	5056/50/3	HN	CL	1	24		
• Cerradero ref. CE56AD ó CE56AI	56A60D/1	35	60	5056/50/3	HE	CL	1	24		
• Embellecedor ES125	56A60I/1	35	60	5056/50/3	HE	CL	1	24		
	56A70D/0	45	70	5056/50/3	HN	CL	1	24		
Opcional	56A70I/0	45	70	5056/50/3	HN	CL	1	24		
• Cerradero CELC56/1A ó CELC56/1BA	56A70D/1	45	70	5056/50/3	HE	CL	1	24		
	56A70I/1	45	70	5056/50/3	HE	CL	1	24		
<hr/>										
• Cilindro redondo ref. 5156/50/3	156A60D/0	35	60	5156/50/3	HN	CL	1	24		
	156A60I/0	35	60	5156/50/3	HN	CL	1	24		
• Cerradero ref. CE56AD ó CE56AI	156A60D/1	35	60	5156/50/3	HE	CL	1	24		
• Embellecedor ES1125	156A60I/1	35	60	5156/50/3	HE	CL	1	24		
	156A70D/0	45	70	5156/50/3	HN	CL	1	24		
	156A70I/0	45	70	5156/50/3	HN	CL	1	24		
Opciones cerraderos eléctricos	156A70D/1	45	70	5156/50/3	HE	CL	1	24		
• CELC56/1A ó CELC56/1BA	156A70I/1	45	70	5156/50/3	HE	CL	1	24		

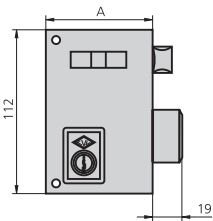

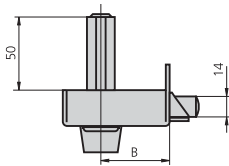
CARACTERÍSTICAS

- Picaporte accionado mediante manilla por ambos lados
- Palanca de una vuelta de llave accionable por ambos lados
- Posibilidad de elección entre cilindro de perfil o cilindro redondo
- Dos acabados: hierro esmaltado y hierro niquelado
- Cerradero según cerradura
- Embellecedor según tipo de cilindro
- Componentes de sujeción

ACCESORIOS OPCIONALES

- Cerraderos eléctricos (ver página 91)
- Cilindro de seguridad

DESCRIPCIÓN	REF.	MEDIDAS		CILINDRO	ACABADOS		UDS		PRECIO	
		B	A		FRENTE	CILINDRO			COMPLETA	S/CILINDRO
• Cilindro perfil ref. 5056/50/3	56B60D/0	35	60	5056/50/3	HN	CL	1	24		
• Cerradero ref. CE56AD ó CE56AI	56B60I/0	35	60	5056/50/3	HN	CL	1	24		
• Picaporte reversible en la medida de 70mm (ref. 56BR)	56B60D/1	35	60	5056/50/3	HE	CL	1	24		
• Embellecedor ES125	56B60I/1	35	60	5056/50/3	HE	CL	1	24		
	56BR70D/0	45	70	5056/50/3	HN	CL	1	24		
	56BR70I/0	45	70	5056/50/3	HN	CL	1	24		
	56BR70D/1	45	70	5056/50/3	HE	CL	1	24		
	56BR70I/1	45	70	5056/50/3	HE	CL	1	24		

Opciones cerraderos eléctricos

- CELC56/1A ó CELC56/1BA

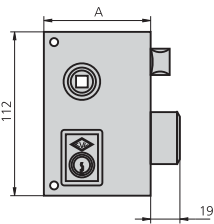

• Cilindro redondo ref. 5156/50/3	156B60D/0	35	60	5156/50/3	HN	CL	1	24		
• Cerradero ref. CE56AD ó CE56AI	156B60I/0	35	60	5156/50/3	HN	CL	1	24		
• Picaporte reversible en la medida de 70mm (ref. 156BR)	156B60D/1	35	60	5156/50/3	HE	CL	1	24		
• Embellecedor ES1125	156B60I/1	35	60	5156/50/3	HE	CL	1	24		
	156BR70D/0	45	70	5156/50/3	HN	CL	1	24		
	156BR70I/0	45	70	5156/50/3	HN	CL	1	24		
	156BR70D/1	45	70	5156/50/3	HE	CL	1	24		
	156BR70I/1	45	70	5156/50/3	HE	CL	1	24		

Opciones cerraderos eléctricos

- CELC56/1A ó CELC56/1BA

CERRADURA DE SOBREPONER SERIE 56

SERIE 56C

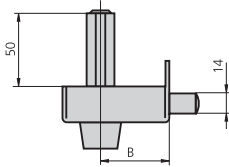

CARACTERÍSTICAS

- Palanca de una vuelta de llave accionable por ambos lados
- Posibilidad de elección entre cilindro de perfil o cilindro redondo
- Dos acabados: hierro esmaltado y hierro niquelado
- Cerradero según cerradura
- Embellecedor según tipo de cilindro
- componentes de sujeción

ACCESORIOS OPCIONALES

- Cilindro de seguridad

DESCRIPCIÓN	REF.	MEDIDAS		CILINDRO	ACABADOS		UDS		PRECIO	
		B	A		FRENTE	CILINDRO			COMPLETA	S/CILINDRO
<ul style="list-style-type: none"> • Cilindro perfil ref. 5056/50/3 • Cerradero ref. CE56C/1 ó CE56C/0 • Embellecedor ES125 	56C60D/0	35	60	5056/50/3	HN	CL	1	24		
	56C60I/0	35	60	5056/50/3	HN	CL	1	24		
	56C60D/1	35	60	5056/50/3	HE	CL	1	24		
	56C60I/1	35	60	5056/50/3	HE	CL	1	24		
	56C70D/0	45	70	5056/50/3	HN	CL	1	24		
	56C70I/0	45	70	5056/50/3	HN	CL	1	24		
	56C70D/1	45	70	5056/50/3	HE	CL	1	24		
	56C70I/1	45	70	5056/50/3	HE	CL	1	24		
<ul style="list-style-type: none"> • Cilindro redondo ref. 5156/50/3 • Cerradero ref. CE56C/1 ó CE56C/0 • Embellecedor ES1125 	156C60D/0	35	60	5156/50/3	HN	CL	1	24		
	156C60I/0	35	60	5156/50/3	HN	CL	1	24		
	156C60D/1	35	60	5156/50/3	HE	CL	1	24		
	156C60I/1	35	60	5156/50/3	HE	CL	1	24		
	156C70D/0	45	70	5156/50/3	HN	CL	1	24		
	156C70I/0	45	70	5156/50/3	HN	CL	1	24		
	156C70D/1	45	70	5156/50/3	HE	CL	1	24		
	156C70I/1	45	70	5156/50/3	HE	CL	1	24		

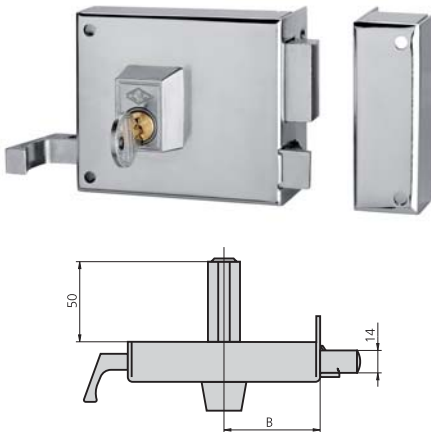

CARACTERÍSTICAS

- Picaporte accionado por llave exteriormente y con llave y tirador desde el interior
- Palanca de dos vueltas de llave accionable por ambos lados
- Posibilidad de elección entre cilindro de perfil o cilindro redondo
- Dos acabados: hierro esmaltado y hierro niquelado
- Cerradero según cerradura
- Embellecedor según tipo de cilindro
- Componentes de sujeción

ACCESORIOS OPCIONALES

- Cerraderos eléctricos (ver página 91)
- Cilindro de seguridad

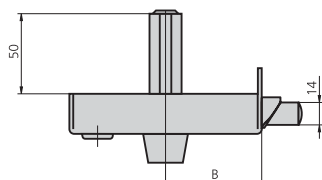
DESCRIPCIÓN	REF.	MEDIDAS		CILINDRO	ACABADOS		UDS		PRECIO	
		B	A		FRENTE	CILINDRO			COMPLETA	S/CILINDRO
<ul style="list-style-type: none"> • Cilindro perfil ref. 5056/50/3 • Picaporte reversible en la medida de 100mm (REF. 125AR) • Cerradero ref. CE125AD ó CE125AI • Embellecedor ES125 <p>Opciones cerraderos eléctricos</p> <ul style="list-style-type: none"> • CELC125/1A ó CELC125/1BA 	125A8D/0	47	90	5056/50/3	HN	CL	1	20		
	125A8I/0	47	90	5056/50/3	HN	CL	1	20		
	125A8D/1	47	90	5056/50/3	HE	CL	1	20		
	125A8I/1	47	90	5056/50/3	HE	CL	1	20		
	125AR10D/0	60	100	5056/50/3	HN	CL	1	20		
	125AR10I/0	60	100	5056/50/3	HN	CL	1	20		
	125AR10D/1	60	100	5056/50/3	HE	CL	1	20		
	125AR10I/1	60	100	5056/50/3	HE	CL	1	20		
	125A12D/0	60	120	5056/50/3	HN	CL	1	20		
	125A12I/0	60	120	5056/50/3	HN	CL	1	20		
	125A12D/1	60	120	5056/50/3	HE	CL	1	20		
	125A12I/1	60	120	5056/50/3	HE	CL	1	20		
	125A14D/0	70	140	5056/50/3	HN	CL	1	20		
	125A14I/0	70	140	5056/50/3	HN	CL	1	20		
	125A14D/1	70	140	5056/50/3	HE	CL	1	20		
	125A14I/1	70	140	5056/50/3	HE	CL	1	20		
<ul style="list-style-type: none"> • Cilindro redondo ref. 5156/50/3 • Picaporte reversible en la medida de 100mm (REF. 1125AR) • Cerradero ref. CE125AD ó CE125AI • Embellecedor ES1125 <p>Opciones cerraderos eléctricos</p> <ul style="list-style-type: none"> • CELC125/1A ó CELC125/1BA 	1125A8D/0	47	90	5156/50/3	HN	CL	1	20		
	1125A8I/0	47	90	5156/50/3	HN	CL	1	20		
	1125A8D/1	47	90	5156/50/3	HE	CL	1	20		
	1125A8I/1	47	90	5156/50/3	HE	CL	1	20		
	1125AR10D/0	60	100	5156/50/3	HN	CL	1	20		
	1125AR10I/0	60	100	5156/50/3	HN	CL	1	20		
	1125AR10D/1	60	100	5156/50/3	HE	CL	1	20		
	1125AR10I/1	60	100	5156/50/3	HE	CL	1	20		
	1125A12D/0	60	120	5156/50/3	HN	CL	1	20		
	1125A12I/0	60	120	5156/50/3	HN	CL	1	20		
	1125A12D/1	60	120	5156/50/3	HE	CL	1	20		
	1125A12I/1	60	120	5156/50/3	HE	CL	1	20		
	1125A14D/0	70	140	5156/50/3	HN	CL	1	20		
	1125A14I/0	70	140	5156/50/3	HN	CL	1	20		
	1125A14D/1	70	140	5156/50/3	HE	CL	1	20		
	1125A14I/1	70	140	5156/50/3	HE	CL	1	20		



CARACTERÍSTICAS

- Picaporte accionado por manilla por ambos lados
- Picaporte reversible
- Palanca de dos vueltas de llave accionable por ambos lados
- Posibilidad de elección entre cilindro de perfil o cilindro redondo
- Dos acabados: hierro esmaltado y hierro niquelado
- Cerradero según cerradura
- Embellecedor según tipo de cilindro
- Componentes de sujeción

ACCESORIOS OPCIONALES

- Cerraderos eléctricos (ver página 91)
- Cilindro de seguridad

DESCRIPCIÓN	REF.	MEDIDAS		CILINDRO	ACABADOS		UDS		PRECIO	
		B	A		FRENTE	CILINDRO			COMPLETA	S/CILINDRO
• Cilindro perfil ref. 5056/50/3	125BR12D/0	60	120	5056/50/3	HN	CL	1	24		
• Picaporte reversible	125BR12I/0	60	120	5056/50/3	HN	CL	1	24		
• Cerradero ref. CE125AD ó CE125AI	125BR12D/1	60	120	5056/50/3	HE	CL	1	24		
• Embellecedor ES125	125BR12I/1	60	120	5056/50/3	HE	CL	1	24		
Opciones cerraderos eléctricos	125BR14D/0	70	140	5056/50/3	HN	CL	1	24		
• CELC125/1A ó CELC125/1BA	125BR14I/0	70	140	5056/50/3	HN	CL	1	24		
	125BR14D/1	70	140	5056/50/3	HE	CL	1	24		
	125BR14I/1	70	140	5056/50/3	HE	CL	1	24		

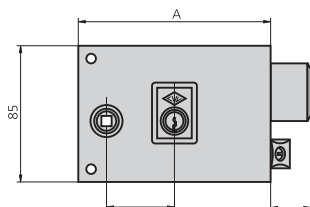

- Cilindro redondo ref. 5156/50/3
- Picaporte reversible
- Cerradero ref. CE125AD ó CE125AI
- Embellecedor ES1125

Opciones cerraderos eléctricos

- CELC125/1A ó CELC125/1BA

1125BR12D/0	60	120	5156/50/3	HN	CL	1	24		
1125BR12I/0	60	120	5156/50/3	HN	CL	1	24		
1125BR12D/1	60	120	5156/50/3	HE	CL	1	24		
1125BR12I/1	60	120	5156/50/3	HE	CL	1	24		
1125BR14D/0	70	140	5156/50/3	HN	CL	1	24		
1125BR14I/0	70	140	5156/50/3	HN	CL	1	24		
1125BR14D/1	70	140	5156/50/3	HE	CL	1	24		
1125BR14I/1	70	140	5156/50/3	HE	CL	1	24		

CARACTERÍSTICAS

- Palanca de dos vueltas de llave accionable por ambos lados
- Posibilidad de elección entre cilindro de perfil o cilindro redondo
- Dos acabados: hierro esmaltado y hierro niquelado
- Cerradero según cerradura
- Embellecedor según tipo de cilindro
- Componentes de sujeción

ACCESORIOS OPCIONALES

- Cilindro de seguridad

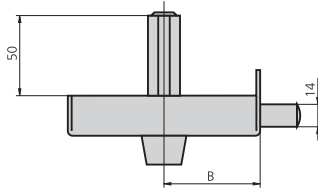

DESCRIPCIÓN	REF.	MEDIDAS		CILINDRO	ACABADOS		UDS		PRECIO	
		B	A		FRENTE	CILINDRO			COMPLETA	S/CILINDRO
<ul style="list-style-type: none"> • Cilindro perfil ref. 5056/50/3 • Cerradero ref. CE125AD ó CE125AI • Embellecedor ES125 	124A8D/0	47	90	5056/50/3	HN	CL	1	24		
	124A8I/0	47	90	5056/50/3	HN	CL	1	24		
	124A8D/1	47	90	5056/50/3	HE	CL	1	24		
	124A8I/1	47	90	5056/50/3	HE	CL	1	24		
	124A10D/0	60	100	5056/50/3	HN	CL	1	24		
	124A10I/0	60	100	5056/50/3	HN	CL	1	24		
	124A10D/1	60	100	5056/50/3	HE	CL	1	24		
	124A10I/1	60	100	5056/50/3	HE	CL	1	24		
	124A12D/0	60	120	5056/50/3	HN	CL	1	24		
	124A12I/0	60	120	5056/50/3	HN	CL	1	24		
	124A12D/1	60	120	5056/50/3	HE	CL	1	24		
	124A12I/1	60	120	5056/50/3	HE	CL	1	24		
	124A14D/0	70	140	5056/50/3	HN	CL	1	24		
	124A14I/0	70	140	5056/50/3	HN	CL	1	24		
124A14D/1	70	140	5056/50/3	HE	CL	1	24			
124A14I/1	70	140	5056/50/3	HE	CL	1	24			
<ul style="list-style-type: none"> • Cilindro redondo ref. 5156/50/3 • Cerradero ref. CE125AD ó CE125AI • Embellecedor ES1125 	1124A8D/0	47	90	5156/50/3	HN	CL	1	24		
	1124A8I/0	47	90	5156/50/3	HN	CL	1	24		
	1124A8D/1	47	90	5156/50/3	HE	CL	1	24		
	1124A8I/1	47	90	5156/50/3	HE	CL	1	24		
	1124A10D/0	60	100	5156/50/3	HN	CL	1	24		
	1124A10I/0	60	100	5156/50/3	HN	CL	1	24		
	1124A10D/1	60	100	5156/50/3	HE	CL	1	24		
	1124A10I/1	60	100	5156/50/3	HE	CL	1	24		
	1124A12D/0	60	120	5156/50/3	HN	CL	1	24		
	1124A12I/0	60	120	5156/50/3	HN	CL	1	24		
	1124A12D/1	60	120	5156/50/3	HE	CL	1	24		
	1124A12I/1	60	120	5156/50/3	HE	CL	1	24		
	1124A14D/0	70	140	5156/50/3	HN	CL	1	24		
	1124A14I/0	70	140	5156/50/3	HN	CL	1	24		
1124A14D/1	70	140	5156/50/3	HE	CL	1	24			
1124A14I/1	70	140	5156/50/3	HE	CL	1	24			

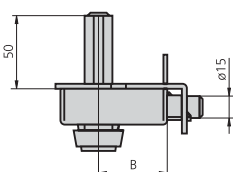

CARACTERÍSTICAS

- Cerradura de sobreponer reforzada
- Picaporte accionado por llave exteriormente y con llave o pomo desde el interior
- Palanca de 3 bulones de acero a dos vueltas de llave accionable por ambos lados del cilindro
- Sistema antipalanqueta
- Posibilidad de elección entre cilindro de perfil o cilindro redondo
- Dos acabados: hierro esmaltado y hierro niquelado
- Cerradero según cerradura
- Embellecedor según tipo de cilindro
- Componentes de sujeción

ACCESORIOS OPCIONALES

- Cilindro de seguridad

DESCRIPCIÓN

REF.	MEDIDAS CILINDRO		ACABADOS		UDS		PRECIO	
	B	A	FRENTE	CILINDRO			COMPLETA	S/CILINDRO

- Cilindro perfil ref. 5056/50/3
- Cerradero ref. CE122AD ó CE122AI
- Embellecedor ES125

122A70D/0	45	70	5056/50/3	HN	CL	1	10		
122A70I/0	45	70	5056/50/3	HN	CL	1	10		
122A70D/1	45	70	5056/50/3	HE	CL	1	10		
122A70I/1	45	70	5056/50/3	HE	CL	1	10		

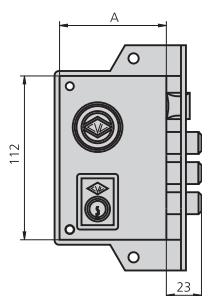

- Cilindro redondo ref. 5156/50/3
- Cerradero ref. CE122AD ó CE122AI
- Embellecedor ES1125

1122A70D/0	45	70	5156/50/3	HN	CL	1	10		
1122A70I/0	45	70	5156/50/3	HN	CL	1	10		
1122A70D/1	45	70	5156/50/3	HE	CL	1	10		
1122A70I/1	45	70	5156/50/3	HE	CL	1	10		

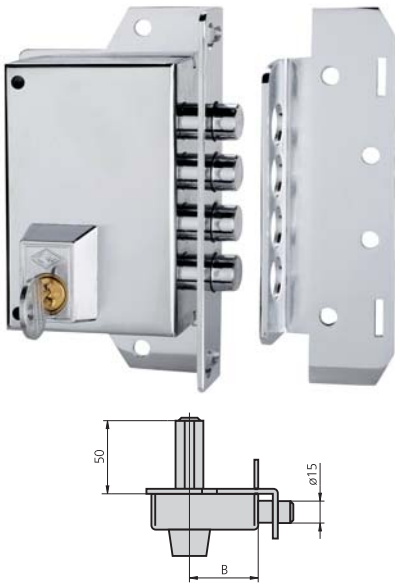
CARACTERÍSTICAS

- Cerradura de sobreponer reforzada
- Palanca de 4 bulones de acero a dos vueltas de llave accionable por ambos lados del cilindro
- Sistema antipalanqueta
- Posibilidad de elección entre cilindro de perfil o cilindro redondo
- Dos acabados: hierro esmaltado y hierro niquelado
- Cerradero según cerradura
- Embellecedor según tipo de cilindro
- Componentes de sujeción

ACCESORIOS OPCIONALES

- Cilindro de seguridad

DESCRIPCIÓN
REF.
MEDIDAS CILINDRO
ACABADOS
UDS
PRECIO
B A
FRENTE CILINDRO

COMPLETA S/CILINDRO

- Cilindro perfil ref. 5056/50/3
- Cerradero ref. CE122C/1 ó CE122C/0
- Embellecedor ES125

122C70D/0	45	70	5056/50/3	HN	CL	1	10		
122C70I/0	45	70	5056/50/3	HN	CL	1	10		
122C70D/1	45	70	5056/50/3	HE	CL	1	10		
122C70I/1	45	70	5056/50/3	HE	CL	1	10		

- Cilindro redondo ref. 5156/50/3
- Cerradero ref. CE122C/1 ó CE122C/0
- Embellecedor ES1125

1122C70D/0	45	70	5156/50/3	HN	CL	1	10		
1122C70I/0	45	70	5156/50/3	HN	CL	1	10		
1122C70D/1	45	70	5156/50/3	HE	CL	1	10		
1122C70I/1	45	70	5156/50/3	HE	CL	1	10		

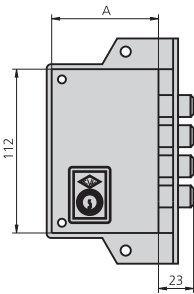

CERRADURA DE SOBREPONER SERIE 123

SERIE 123A

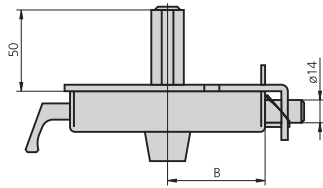

CARACTERÍSTICAS

- Cerradura de sobreponer reforzada
- Picaporte accionable mediante llave por el exterior y con tirador o llave desde el interior
- Palanca de 3 bulones de acero a dos vueltas de llave accionable por ambos lados del cilindro
- Sistema antipalanqueta
- Posibilidad de elección entre cilindro de perfil o cilindro redondo
- Dos acabados: hierro esmaltado y hierro niquelado
- Cerradero según cerradura
- Embellecedor según tipo de cilindro
- Componentes de sujeción

ACCESORIOS OPCIONALES

- Cilindro de seguridad

DESCRIPCIÓN	REF.	MEDIDAS		CILINDRO	ACABADOS		UDS		PRECIO	
		B	A		FRENTE	CILINDRO			COMPLETA	S/CILINDRO
<ul style="list-style-type: none"> • Cilindro perfil ref. 5056/50/3 • Cerradero ref. CE123AD ó CE123AI • Embellecedor ES125 	123A10D/0	60	100	5056/50/3	HN	CL	1	10		
	123A10I/0	60	100	5056/50/3	HN	CL	1	10		
	123A10D/1	60	100	5056/50/3	HE	CL	1	10		
	123A10I/1	60	100	5056/50/3	HE	CL	1	10		
	123A12D/0	60	120	5056/50/3	HN	CL	1	10		
	123A12I/0	60	120	5056/50/3	HN	CL	1	10		
	123A12D/1	60	120	5056/50/3	HE	CL	1	10		
	123A12I/1	60	120	5056/50/3	HE	CL	1	10		
<ul style="list-style-type: none"> • Cilindro redondo ref. 5156/50/3 • Cerradero ref. CE123AD ó CE123AI • Embellecedor ES1125 	1123A10D/0	60	100	5156/50/3	HN	CL	1	10		
	1123A10I/0	60	100	5156/50/3	HN	CL	1	10		
	1123A10D/1	60	100	5156/50/3	HE	CL	1	10		
	1123A10I/1	60	100	5156/50/3	HE	CL	1	10		
	1123A12D/0	60	120	5156/50/3	HN	CL	1	10		
	1123A12I/0	60	120	5156/50/3	HN	CL	1	10		
	1123A12D/1	60	120	5156/50/3	HE	CL	1	10		
	1123A12I/1	60	120	5156/50/3	HE	CL	1	10		

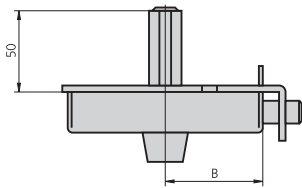
CARACTERÍSTICAS

- Cerradura de sobreponer reforzada
- Palanca de 4 bulones de acero a dos vueltas de llave accionable por ambos lados del cilindro
- Sistema antipalanqueta
- Posibilidad de elección entre cilindro de perfil o cilindro redondo
- Dos acabados: hierro esmaltado y hierro niquelado
- Cerradero según cerradura
- Embellecedor según tipo de cilindro
- Componentes de sujeción

ACCESORIOS OPCIONALES

- Cilindro de seguridad

DESCRIPCIÓN

REF.	MEDIDAS		CILINDRO	ACABADOS		UDS		PRECIO	
	B	A		FRENTE	CILINDRO			COMPLETA	S/CILINDRO

- Cilindro perfil ref. 5056/50/3
- Cerradero ref. CE123C/1 ó CE123C/1
- Embellecedor ES125

123C10D/0	60	100	5056/50/3	HN	CL	1	10		
123C10I/0	60	100	5056/50/3	HN	CL	1	10		
123C10D/1	60	100	5056/50/3	HE	CL	1	10		
123C10I/1	60	100	5056/50/3	HE	CL	1	10		
123C12D/0	60	120	5056/50/3	HN	CL	1	10		
123C12I/0	60	120	5056/50/3	HN	CL	1	10		
123C12D/1	60	120	5056/50/3	HE	CL	1	10		
123C12I/1	60	120	5056/50/3	HE	CL	1	10		

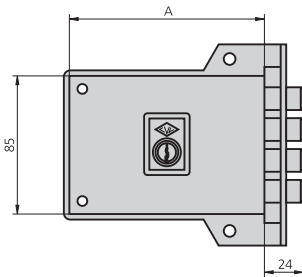

- Cilindro redondo ref. 5156/50/3
- Cerradero ref. CE123C/1 ó CE123C/1
- Embellecedor ES1125

1123C10D/0	60	100	5156/50/3	HN	CL	1	10		
1123C10I/0	60	100	5156/50/3	HN	CL	1	10		
1123C10D/1	60	100	5156/50/3	HE	CL	1	10		
1123C10I/1	60	100	5156/50/3	HE	CL	1	10		
1123C12D/0	60	120	5156/50/3	HN	CL	1	10		
1123C12I/0	60	120	5156/50/3	HN	CL	1	10		
1123C12D/1	60	120	5156/50/3	HE	CL	1	10		
1123C12I/1	60	120	5156/50/3	HE	CL	1	10		

CERROJOS

SERIE 1976



CARACTERÍSTICAS

- Cerrojo de seguridad reversible aplicable a puertas metálicas basculantes o enrollables
- Se suministra por parejas con la misma llave
- Palanca deslizante de acero accionable por llave desde el exterior
- Cilindro exterior redondo diámetro 26mm
- Acabado en hierro esmaltado

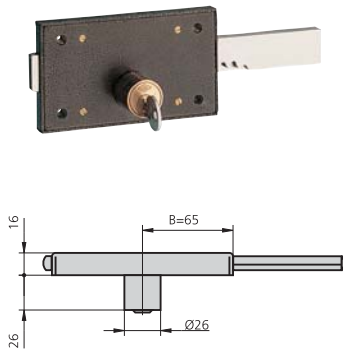
ACCESORIOS OPCIONALES



DESCRIPCIÓN

REF.	MEDIDAS		CILINDRO	ACABADOS		UDS		PRECIO	
	B	A		FRENTE	CILINDRO			COMPLETA	S/CILINDRO

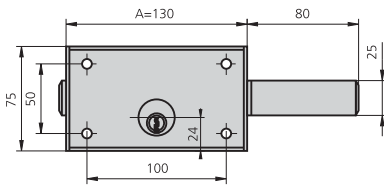

1976/1	65	130	Ø 26mm	HE	CL	1	17		
--------	----	-----	--------	----	----	---	----	--	--

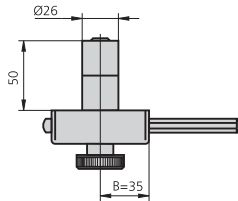
CARACTERÍSTICAS

- Cerrojo de seguridad reversible
- Palanca deslizante de acero accionable por llave desde el exterior y mediante pomo desde el interior
- Cilindro exterior redondo diámetro 26mm
- Dos acabados: hierro esmaltado y hierro niquelado
- Cerradero CE1978/1 ó CE1978/0
- Embellecedor ES1125
- Componentes de sujeción

ACCESORIOS OPCIONALES

- Cilindro de seguridad
- Cilindros de distintas longitudes

DESCRIPCIÓN

REF.	MEDIDAS		CILINDRO	ACABADOS		UDS		PRECIO	
	B	A		FRENTE	CILINDRO			COMPLETA	S/CILINDRO

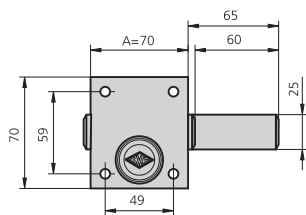

1978/0	35	70	Ø 26mm	HN	CL	1	20		
1978/1	35	70	Ø 26mm	HE	CL	1	20		

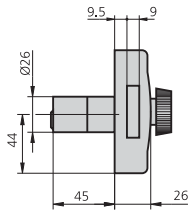

CARACTERÍSTICAS

- Cerrojo de seguridad reversible
- Palanca deslizante de acero accionable por llave desde el exterior y mediante pomo desde el interior
- Cilindro exterior redondo diámetro 26mm
- Dos acabados: hierro esmaltado y hierro niquelado
- Cerradero CE1988/1 ó CE1988/0
- Embellecedor ES1125
- Componentes de sujeción

ACCESORIOS OPCIONALES

- Cilindro de seguridad
- Cilindros de distintas longitudes

DESCRIPCIÓN

REF.	MEDIDAS		CILINDRO	ACABADOS		UDS		PRECIO	
	B	A		FRENTE	CILINDRO			COMPLETA	S/CILINDRO

1988/0	56	Ø 26mm	HN	CL	1	24		
1988/1	56	Ø 26mm	HE	CL	1	24		

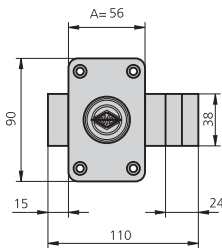

CARACTERÍSTICAS

- Picaporte reversible de sobreponer
- Picaporte accionable mediante manilla
- Cuadradillo para manilla de 8mm
- Acabado en hierro esmaltado
- Cerradero CE234/1
- Embellecedor ES234

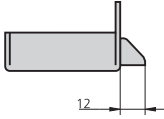
ACCESORIOS OPCIONALES

DESCRIPCIÓN	REF.	MEDIDAS		CILINDRO	ACABADOS		UDS		PRECIO	
		B	A		FRENTE	CILINDRO			COMPLETA	S/CILINDRO
	234/50/1	30	50	-	HE		6	120		
	234/60/1	38	60	-	HE		6	120		
	234/70/1	46	70	-	HE		6	120		



CARACTERÍSTICAS

- Picaporte reversible de sobreponer
- Condena accionable mediante tirador
- Cuadradillo para manilla de 8mm
- Acabado en hierro esmaltado
- Cerradero CE236/1
- Embellecedor ES234

ACCESORIOS OPCIONALES

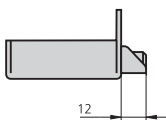

DESCRIPCIÓN

REF.	MEDIDAS			CILINDRO		ACABADOS		UDS		PRECIO	
	B	A		FRENTE	CILINDRO			COMPLETA	S/CILINDRO		

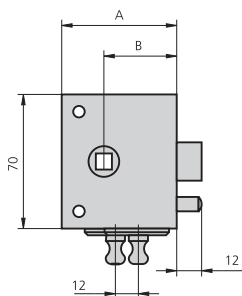

236/50/1	30	50	-	HE		6	120		
236/60/1	38	60	-	HE		6	120		
236/70/1	46	70	-	HE		6	120		

ACCESORIOS

CERRADEROS ELÉCTRICOS

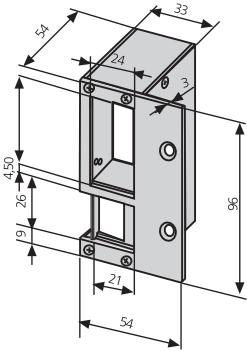
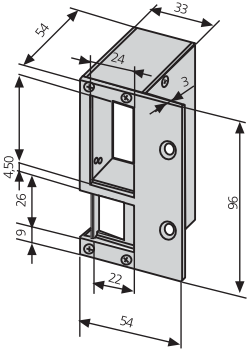
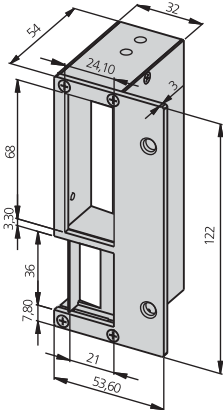
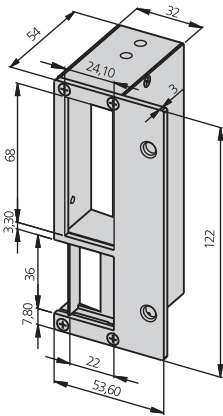
DESCRIPCIÓN	REF.	PARA	PRECIO	
			COMPLETA	S/CILINDRO
 <ul style="list-style-type: none"> Cerradero eléctrico reversible de 96mm con sujeción oculta para cerraduras horizontales con cerrojo (RF. 125) que tengan un espesor de 20mm 	CELC125/1A	125, 1125		
 <ul style="list-style-type: none"> Cerradero eléctrico reversible de 96mm con sujeción oculta para cerraduras horizontales con cerrojo (RF. 125) que tengan un espesor superior a 20mm 	CELC125/1BA	125, 1125		
 <ul style="list-style-type: none"> Cerradero eléctrico reversible de 122mm con sujeción oculta para cerraduras horizontales con cerrojo (ref. 56) que tengan un espesor de 20mm 	CELC56/1A	56, 156		
 <ul style="list-style-type: none"> Cerradero eléctrico reversible de 122mm con sujeción oculta para cerraduras horizontales con cerrojo (ref. 56) que tengan un espesor superior a 20mm 	CELC56/1BA	56, 156		

CERRADURAS DE SOBREPONER